

## Errata

**Title & Document Type:** 16532A Digitizing Oscilloscope Service Manual

**Manual Part Number:** 16532-97002

**Revision Date:** July 1993

---

### HP References in this Manual

This manual may contain references to HP or Hewlett-Packard. Please note that Hewlett-Packard's former test and measurement, semiconductor products and chemical analysis businesses are now part of Agilent Technologies. We have made no changes to this manual copy. The HP XXXX referred to in this document is now the Agilent XXXX. For example, model number HP8648A is now model number Agilent 8648A.

### About this Manual

We've added this manual to the Agilent website in an effort to help you support your product. This manual provides the best information we could find. It may be incomplete or contain dated information, and the scan quality may not be ideal. If we find a better copy in the future, we will add it to the Agilent website.

### Support for Your Product

Agilent no longer sells or supports this product. You will find any other available product information on the Agilent Test & Measurement website:

[www.tm.agilent.com](http://www.tm.agilent.com)

Search for the model number of this product, and the resulting product page will guide you to any available information. Our service centers may be able to perform calibration if no repair parts are needed, but no other support from Agilent is available.



## **SERVICE MANUAL**

# **HP 16532A 1 GSa/s Digitizing Oscilloscope**

© COPYRIGHT HEWLETT-PACKARD COMPANY,  
COLORADO SPRINGS DIVISION 1991-1993  
1900 GARDEN OF THE GODS ROAD, COLORADO SPRINGS, COLORADO U.S.A.

ALL RIGHTS RESERVED

## SAFETY CONSIDERATIONS

**GENERAL** - This is a Safety Class I instrument (provided with terminal for protective earthing).

**OPERATION** - BEFORE APPLYING POWER verify that the power transformer primary is matched to the available line voltage, the correct fuse is installed, and Safety Precautions are taken (see the following warnings). In addition, note the instrument's external markings which are described under "Safety Symbols."

### WARNING

- Servicing instructions are for use by service-trained personnel. To avoid dangerous electric shock, do not perform any servicing unless qualified to do so.
- BEFORE SWITCHING ON THE INSTRUMENT, the protective earth terminal of the instrument must be connected to the protective conductor of the (mains) powercord. The mains plug shall only be inserted in a socket outlet provided with a protective earth contact. The protective action must not be negated by the use of an extension cord (power cable) without a protective conductor (grounding). Grounding one conductor of a two-conductor outlet is not sufficient protection.
- If this instrument is to be energized via an auto-transformer (for voltage reduction) make sure the common terminal is connected to the earth terminal of the power source.
- Any interruption of the protective (grounding) conductor (inside or outside the instrument) or disconnecting the protective earth terminal will cause a potential shock hazard that could result in personal injury.
- Whenever it is likely that the protection has been impaired, the instrument must be made inoperative and be secured against any unintended operation.
- Only fuses with the required rated current, voltage, and specified type (normal blow, time delay, etc.) should be used. Do not use repaired fuses or short circuited fuse-holders. To do so could cause a shock or fire hazard.
- Do not operate the instrument in the presence of flammable gasses or fumes. Operation of any electrical instrument in such an environment constitutes a definite safety hazard.

- Do not install substitute parts or perform any unauthorized modification to the instrument.
- Adjustments described in the manual are performed with power supplied to the instrument while protective covers are removed. Energy available at many points may, if contacted, result in personal injury.
- Any adjustment, maintenance, and repair of the opened instrument under voltage should be avoided as much as possible, and when inevitable, should be carried out only by a skilled person who is aware of the hazard involved.
- Capacitors inside the instrument may still be charged even if the instrument has been disconnected from its source of supply.

### SAFETY SYMBOLS



Instruction manual symbol. The product will be marked with this symbol when it is necessary for the user to refer to the instruction manual in order to protect against damage to the product.



Indicates hazardous voltages



Earth terminal (sometimes used in manual to indicate circuit common connected to grounded chassis).

### WARNING

The WARNING sign denotes a hazard. It calls attention to a procedure, practice, or the like, which, if not correctly performed or adhered to, could result in personal injury. Do not proceed beyond a WARNING sign until the indicated conditions are fully understood and met.

### CAUTION

The CAUTION sign denotes a hazard. It calls attention to an operating procedure, practice, or the like, which, if not correctly performed or adhered to, could result in damage to or destruction of part or all of the product. Do not proceed beyond a CAUTION sign until the indicated conditions are fully understood or met.

# CONTENTS

## SECTION I

### General Information

1-1. Introduction .....	1-1
1-2. Module Covered by This Manual .....	1-1
1-3. Safety Requirements .....	1-1
1-4. Product Description .....	1-2
1-5. Accessories Supplied .....	1-2
1-6. Accessories Available.....	1-2
1-7. Specifications .....	1-2
1-8. Operating Characteristics .....	1-2
1-9. Recommended Test Equipment .....	1-2

## SECTION II

### Installation

2-1. Introduction .....	2-1
2-2. Initial Inspection .....	2-1
2-3. Preparation for Use .....	2-1
2-4. Power Requirements .....	2-1
2-5. Safety Requirements .....	2-1
2-6. Module Installation .....	2-1
2-7. Operating Environment .....	2-4
2-8. Storage .....	2-4
2-9. Packaging .....	2-4
2-10. Tagging for Service .....	2-4

## SECTION III

### Performance Tests

3-1. Introduction .....	3-1
3-2. Recommended Test Equipment .....	3-1
3-3. Test Record .....	3-1
3-4. Performance Test Interval .....	3-1
3-5. Performance Test Procedures .....	3-1
3-6. DC CAL OUTPUT Test .....	3-2
3-7. AC CAL OUTPUT Test .....	3-3
3-8. Input Resistance .....	3-4
3-9. Voltage Measurement Accuracy .....	3-6
3-10. Offset Accuracy .....	3-9
3-11. Bandwidth .....	3-11
3-12. Time Measurement Accuracy .....	3-13
3-13. Trigger Sensitivity .....	3-15

**SECTION IV**

**Calibration**

4-1. Introduction.....	4-1
4-2. Safety Requirements .....	4-1
4-3. Calibration Interval.....	4-1
4-4. Maintaining System Integrity.....	4-1
4-5. Calibration Protection Switch.....	4-1
4-6. Recommended Test Equipment .....	4-2
4-7. Instrument Warmup .....	4-2
4-8. Calibration.....	4-2
4-9. Setting the PROTECT/UNPROTECT Switch to UNPROTECT .....	4-3
4-10. Equipment Required for Calibration .....	4-4
4-11. Loading the Default Calibration Factors.....	4-4
4-12. Self Cal Menu Calibrations.....	4-5
4-13. Setting the PROTECT/UNPROTECT Switch to PROTECT .....	4-8
4-14. Sealing the Mainframe.....	4-8

**Section V**

**Replaceable Parts**

5-1. Introduction .....	5-1
5-2. Abbreviations .....	5-1
5-3. Replaceable Parts List .....	5-1
5-4. Ordering Information .....	5-1
5-5. Exchange Assemblies .....	5-1
5-6. Direct Mail Order System .....	5-2

**SECTION VI**

**Service**

6-1. Introduction .....	6-1
6-2. Safety Requirements .....	6-1
6-3. Recommended Test Equipment .....	6-1
6-4. Module Block Diagram and Theory of Operation .....	6-1
6-5. Attenuator Theory of Operation.....	6-1
6-6. Main Assembly Theory of Operation .....	6-1
6-7. Self-Tests .....	6-4
6-8. Troubleshooting .....	6-10
6-9. Oscilloscope Module Removal and Replacement .....	6-18
6-10. Trigger Cable Removal and Replacement .....	6-20
6-11. Attenuator Removal and Replacement .....	6-21

## LIST OF TABLES

TABLE	TITLE	PAGE
1-1.	HP 16532A Specifications.....	1-3
1-2.	HP 16532A Operating Characteristics.....	1-4
1-3.	Recommended Test Equipment.....	1-9
3-1.	Performance Test Record.....	3-17
4-1.	Calibration Sequence.....	4-2
5-1.	Reference Designator and Abbreviations.....	5-3
5-2.	Replaceable Parts List.....	5-5

## LIST OF FIGURES

FIGURE	TITLE	PAGE
2-1.	Endplate Overlap - Top Sequence.....	2-2
2-2.	Endplate Overlap - Bottom Sequence.....	2-3
3-1.	Voltage Measurement Accuracy Test.....	3-7
4-1.	Endplate Overlap - Top Sequence.....	4-3
4-2.	Location of the PROTECT/UNPROTECT Switch.....	4-3
4-3.	Default Calibration Display.....	4-4
4-4.	Ext Trig Null Calibration Connections.....	4-7
4-5.	End of Calibration Display.....	4-8
4-6.	Endplate Overlap - Top Sequence.....	4-8
5-1.	Parts Identification.....	5-4
6-1.	HP 16532A Oscilloscope Block Diagram.....	6-2
6-2.	Startup Screen.....	6-4
6-3.	Load Test System Screen.....	6-5
6-4.	Test System Screen.....	6-5
6-5.	Functional Tests Screen.....	6-6
6-6.	Main Test Menu.....	6-6
6-7.	A/D Test Run Screen.....	6-7
6-8.	Stop Field.....	6-7
6-9.	Exit Test System Screen.....	6-8
6-10.	Troubleshooting Flowchart.....	6-13
6-11.	Endplate Overlap - Top Sequence.....	6-18
6-12.	Endplate Overlap - Bottom Sequence.....	6-19
6-13.	Oscilloscope Module Exploded View.....	6-20

# TABLE OF CONTENTS

## General Information

1-1. Introduction.....	1-1
1-2. Module Covered by Manual .....	1-1
1-3. Safety Requirements.....	1-1
1-4. Product Description .....	1-2
1-5. Accessories Supplied .....	1-2
1-6. Accessories Available .....	1-2
1-7. Specifications.....	1-2
1-8. Operating Characteristics.....	1-2
1-9. Recommended Test Equipment .....	1-2

# SECTION I

## General Information

### 1-1. Introduction

The service policy for this instrument is replacement of defective assemblies. This service guide contains information for finding a defective assembly by testing and servicing the HP 16532A 1 GSa/s Oscilloscope Module. Also included in the guide are installation procedures and a list of recommended test equipment. This guide is divided into six sections as follows:

- I - General Information
- II - Installation
- III - Performance Tests
- IV - Calibration
- V- Replaceable Parts
- VI - Service

The General Information Section includes safety requirements, a product description, and a list of accessories supplied and of accessories available. Also included are tables listing specifications and operating characteristics, and a list of recommended test equipment.

To complete the service documentation for your HP 16500 Logic Analysis System, place this service manual in the 3-ring binder with your other logic analysis system Service Guides.

### 1-2. Module Covered by This Manual

The information covered in this manual is for the HP 16532A 1 GSa/s Oscilloscope Module.

### 1-3. Safety Requirements

Specific warnings, cautions, and instructions are placed wherever applicable throughout the manual. These must be observed during all phases of operation, service, and repair of the module. Failure to comply with them violates safety standards of design, manufacture, and intended use of this module.

Hewlett-Packard assumes no liability for the failure of the customer to comply with these safety requirements.



## 1-4. Product Description

The HP 16532A Oscilloscope Module is a 1 GSa/s digitizing oscilloscope. Some of the main features are:

- 1 GSa/s digitizing for 250 MHz bandwidth single shot analysis.
- 8000 samples per channel.
- Automatic pulse parameters, displays time between markers, acquires until specified time between markers is captured, performs statistical analysis on time between markers.
- Lightweight miniprobes.

## 1-5. Accessories Supplied

The following accessories are supplied with the HP 16532A Oscilloscope module. Quantity one unless shown otherwise.

- User's Reference and Programming Reference set
- Service Guide
- HP 10441A 10:1 probes, Qty 2
- Right angle BNC adapters, Qty 2
- BNC miniprobe adapter
- Master-slave trigger cable
- Operating System Software

## 1-6. Accessories Available

- 10:1, 100:1, 50  $\Omega$ , 10 pf resistive divider probe set, 1.2 m (HP 10020A)
- BNC-to-BNC cable, 1.2 m (HP 10503A)

- 24-pin IC test clip (HP 10211A)
- BNC-to-BNC ac coupling capacitor (HP 10240B)

10:1 Probe:

- 1-M $\Omega$ , 7.5-pf miniprobe, 1 m (HP 10435A)

1:1 Probes:

- 40-pf miniprobe, 1 m (HP 10438A)
- 64-pf miniprobe, 2 m (HP 10439A)
- 50- $\Omega$  miniprobe, 2 m (HP 10437A)

100:1 Probe:

- 10-M $\Omega$ , 2.5-pf miniprobe, 2 m (HP 10440A)

## 1-7. Specifications

Module specifications are listed in table 1-1. These specifications are the performance standards against which the module is tested.

## 1-8. Operating Characteristics

Table 1-2 is a listing of the module operating characteristics. The operating characteristics are not specifications, but are the typical operating characteristics included as additional information for the user.

## 1-9. Recommended Test Equipment

Equipment required to test and maintain the HP 16532A Oscilloscope Module is listed in table 1-3. Other equipment may be substituted if it meets or exceeds the critical specifications listed in the table.

Table 1-1. HP 16532A Specifications

**HP 16532A SPECIFICATIONS****Type:** 2-channel simultaneous acquisition**Bandwidth<sup>(\*,1)</sup>:** dc to 250 MHz (real time, dc-coupled)**Maximum Sample Rate:** 1 Gigasample per second**Number of Channels:** 2, 4, 6, 8 simultaneous channels using the same time base setting(s)

OR

Up to 10 channels with independent time bases for each pair of channels.

Up to 18 channels with the HP 16501A Expansion Frame.

**Rise Time<sup>(2)</sup>:** 1.4 ns**ADC:** 8-bit real time**Vertical Resolution:** 8 bits over 4 vertical divisions ( $\pm 0.4\%$ )**Waveform Record Length:** 8000 points**Time Interval Measurement Accuracy<sup>(\*,3,6)</sup>:**  $\pm [(0.005\% \times \Delta t) + (2 \times 10^{-6} \times \text{delay setting}) + 150 \text{ ps}]$ **Vertical (dc) Gain Accuracy<sup>(4)</sup>:**  $\pm 1.5\%$  of full scale**DC Offset Accuracy<sup>(\*)</sup>:**  $\pm (1.0\%$  of channel offset +  $2.0\%$  of full scale)**Voltage Measurement Accuracy<sup>(\*,5)</sup>:**  $\pm [(1.5\%$  of full scale + offset accuracy) + (0.008 x V/div)]**Trigger Sensitivity<sup>(\*)</sup>:** dc to 50 MHz: 0.063 x full scale, 50 to 250 MHz: 0.125 x full scale**Input Coupling:** 1 M $\Omega$ : ac and dc, 50  $\Omega$ : dc only**Input R (selectable)<sup>(\*)</sup>:** 1 M $\Omega$ :  $\pm 1\%$ , 50  $\Omega$ :  $\pm 1\%$ **Input C:** Approximately 7 pF**NOTES:**

\* Specifications (valid within  $\pm 10^\circ \text{C}$  of auto-calibration temperature, excluding bandwidth— see note 1 for bandwidth specification.)

1. Upper bandwidth reduces by 2.5 MHz for every degree C above  $35^\circ \text{C}$ .

2. Rise time is calculated from the formula:  $t_r = \frac{0.35}{\text{bandwidth}}$

3. Specification applies to the maximum sampling rate. At lower rates, the specification is:  $\pm [(0.005\% \times \Delta t) + (2 \times 10^{-6} \times \text{delay setting}) + (0.15 \times \text{sample interval})]$  for bandwidth limited signals ( $t_r = 1.4 \times \text{sample interval}$ ). Sample interval is defined as  $\frac{1}{\text{sample rate}}$

4. Vertical gain accuracy decreases 0.08% per degree C from software calibration temperature.

5. Digitizing level = (# vertical divisions)  $\left(\frac{1}{2}\right) \left(\frac{1}{\text{LSB}}\right)$ , where  $\text{LSB} = 2^{\# \text{ bits in ADC}}$

6. The Time Interval Measurement Accuracy deteriorates across multiple modules connected as one unit with each added module.

Table 1-2. HP 16532A Operating Characteristics

## HP 16532A OPERATING CHARACTERISTICS

### VERTICAL (at BNC)

**Vertical Sensitivity Range (1:1 Probe):**

4 mV/div to 10 V/div in 1-2-4 increments

**DC Offset Range (1:1 Probe):**

<u>Vertical Sensitivity</u>	<u>Available Offset</u>
4 mV/div to 100 mV/div	± 2 V
> 100 mV/div to 500 mV/div	± 10 V
> 500 mV/div to 2.5 V/div	± 50 V
> 2.5 V/div to 10 V/div	± 250 V

**Probe Factors:**

Any integer ratio from 1:1 to 1000:1

**Maximum Safe Input Voltage:**

1 MΩ: ± 250 V [dc + peak ac (< 10 KHz)]  
 50 Ω: ± 5 VRMS

**Channel-to-Channel Isolation:**

dc to 50 MHz: 40 dB, 50 MHz to 250 MHz: 30 dB

### TIMEBASE

**Range:**

1 ns/div to 5 s/div

**Resolution:**

20 ps

**Delay Pre-trigger Range:**

<u>Time/div Setting</u>	<u>Available Delay</u>
1 μs to 5 s/div	-8 x (s/div)
1 ns to 500 ns/div	-4 μs

**Delay Post-trigger Range:**

<u>Time/div Setting</u>	<u>Available Delay</u>
100 ms to 5 s/div	2.5 ks
1 μs to 50 ms/div	33,500 x (s/div)
1ns to 500 ns/div	16.7 ms

Table 1-2. HP 16532A Operating Characteristics (cont.)

**TRIGGERING****Trigger Level Range:**

Within display window (full scale and offset)

**Trigger Modes:****Immediate:**

Triggers immediately after arming condition is met.

**Edge:**

Triggers on rising or falling edge of any internal channel or external trigger, count adjustable from 1 to 32,000.

**Pattern:**

Triggers on entering, exiting, duration greater than, duration less than, and duration in range for a specified pattern of both internal channels and external trigger, count adjustable from 1 to 32,000. Duration time range is adjustable from 20 ns to 160 ms in 10 ns steps. Duration accuracy is approximately  $\pm 3\%$   $\pm 2$  ns.

**Auto-Trigger:**

If enabled, the module will self-trigger if no trigger condition is found within approximately 50 ms after arming.

**Events Delay:**

The trigger can be set to occur on the nth edge or pattern, as specified by the user. The number of events (n) can be set from 1 to 32,000 events. Maximum count frequency is 70 MHz.

**Intermodule:**

Arms another measurement module or triggers the rear panel BNC.

**External:**

If enabled, the oscilloscope will trigger on an ECL level signal (-1.3 V).

**DIGITIZER**

**Resolution:** 8 bits (1 part in 256)

**Digitizing Rate:** Up to 1 Gigasample per second

**Digitizing Technique:** Real-time digitizing; each 8000 samples are acquired on a single acquisition

**Acquisition Memory Size:** 8000 samples per channel

Table 1-2. HP 16532A Operating Characteristics (cont.)

## **WAVEFORM DISPLAY**

### **Displayed Waveforms:**

Eight waveform windows maximum, with scrolling across 96 waveforms.

### **Display Formats:**

Waveforms can be displayed in an overlapping and/or non-overlapping format. Display capability of A- B and A+ B is also provided.

### **Display Resolution:**

500 points horizontal, 240 points vertical

## **DISPLAY MODES**

### **Normal (Single):**

New acquisition replaces old acquisition on screen.

### **Accumulate:**

New acquisition is displayed in addition to previous acquisitions until screen is erased.

### **Average:**

New acquisitions are averaged with old acquisitions, with the updated waveform displayed until erased. Maximum number of averages is 256.

### **Overlay:**

Up to 8 acquired waveforms from separate channels can be overlaid in the same display area.

### **Connect-the-dots:**

Provides a display of the sample points connected by straight lines.

### **Waveform Reconstruction:**

When there is insufficient data to fill every horizontal location, a post acquisition reconstruction filter fills in missing data points for time base < 50 ns/div.

### **Waveform Math:**

Display capability of A- B and A+ B functions is provided.

Table 1-2. HP 16532A Operating Characteristics (cont.)

**MEASUREMENT AIDS**

**Time Markers:**

Two vertical markers, X and O, are provided for measurements of time and voltage. Capabilities are: measure voltage at point where X and O markers cross each analog waveform; measure time from trigger to X, trigger to O, and X to O; automatic marker placement by specifying percentage of edge, edge number, and rising or falling edge type; run until X to O > than, < than, in range, and not in range provides selective event search; X to O statistics (mean, max, and min) provide analysis of time interval deviation.

**Automatic Search:**

Searches for a percentage or an absolute voltage level at a positive or negative edge, count adjustable from 1 to 100.

**Auto Search Statistics:**

Mean, maximum, and minimum values for elapsed time from X to O markers for multiple runs. Number of valid runs and total number of runs available.

**Automatic Measurements:**

The following pulse parameter measurements can be performed automatically:

Frequency	Rise time	+ pulse width
Period	Fall time	- pulse width
V p-p	Preshoot	V amplitude*
	Overshoot	

(\* gives difference between top and base voltages; only available over bus)

**Grid:**

Graticules can be displayed in background of waveform.

**Voltage Markers:**

Two horizontal markers, A and B, are provided for voltage measurements. These markers can each be placed on any acquisition channel trace. A delta voltage display provides delta V between markers on the same channel or between two channels.

Table 1-2. HP 16532A Operating Characteristics (cont.)

## **SETUP AIDS**

### **Autoscale:**

Autoscales the vertical and horizontal ranges, offset, and trigger level to display the input signals. Requires a frequency between 50 Hz and 250 MHz.

### **Presets:**

Scales the vertical range, offset, and trigger level to predetermined values for displaying ECL or TTL waveforms.

### **Calibration:**

Vertical, trigger, delay, and all defaults. Calibration factors stored in NV-RAM on the circuit board.

### **Probe Compensation Source:**

External BNC supplies a square wave approximately 0.0 mV to -800 mV into the open circuit at approximately 1000 Hz.

## **OPERATING ENVIRONMENT**

### **Temperature:**

Instrument, 0° to 55° C (+ 32° to 131° F). Probes and cables, 0° to 65° C (+ 32° to 149° F).

### **Humidity:**

Instrument, up to 95% relative humidity at + 40° C (+ 104° F). Recommended disk media, 8% to 80% relative humidity at + 40° C (+ 104° F).

### **Altitude:**

To 4600 m (15,000 ft).

### **Vibration**

#### **Operation:**

Random vibration 5-500 Hz, 10 minutes per axis, ~ 0.3 g (rms).

#### **Non-operating:**

Random vibration 5-500 Hz, 10 minutes per axis, ~ 2.41 g (rms); and swept sine resonant search, 5-500 Hz, 0.75 g (0- peak), 5 minute resonant dwell @ 4 resonances per axis.

Table 1-3. Recommended Test Equipment

EQUIPMENT	CRITICAL SPECIFICATIONS	RECOMMENDED MODEL	USE*
Signal Generator	Frequency: 1 - 250 MHz at approx . 170 mV RMS resolution Output Accuracy: $\pm 1$ dB 1 MHz time base accuracy 0.25 ppm	HP 8656B Option 001	P
Dc Power Supply	Range: $- 35.000$ to $+ 35.000$ Vdc, $\pm 1$ mV	HP 6114A	P
Digital Multimeter	0.1 mV resolution Accuracy: better than 0.005% Resistance measurement: better than 0.25% accuracy	HP 3458A	P
Power Meter/Sensor	1 - 250 MHz $\pm 3\%$ accuracy	HP 436/8482A	P
Power Splitter	Outputs differ by $< 0.15$ dB	HP 11667B	P
Blocking Capacitor	50 $\Omega$ BNC (m-to-f), 0.18 $\mu$ F, $\pm 200$ V	HP 10240B	P
Adapter	50 $\Omega$ BNC (m)(m)	HP 1250-1236	C
Adapter	50 $\Omega$ Type N(m)-to-BNC(m)	HP 1250-0082	P
Adapter	50 $\Omega$ BNC(f)-to-Dual Banana Plug	HP 1251-2277	P
Adapter	50 $\Omega$ Type N(m)-to-BNC(f)	HP 1250-0780	P
Tee Adapter	50 $\Omega$ BNC (m)(f)(f)	HP 1250-0781	P,C
Cable	Type N(m-to-m) 24-inch	HP 11500B	P
Cable	50 $\Omega$ BNC (m-to-m) 48-inch	HP 10503A	P
Cable	50 $\Omega$ BNC (m-to-m) 9 inch	HP 10502A	C
Cable	50 $\Omega$ BNC-SMB	HP 16532-61601	C
* P= Performance Tests                      C= Calibrations			



# TABLE OF CONTENTS

## Installation

2-1.	Introduction .....	2-1
2-2.	Initial Inspection .....	2-1
2-3.	Preparation for Use .....	2-1
2-4.	Power Requirements .....	2-1
2-5.	Safety Requirements .....	2-1
2-6.	Module Installation .....	2-1
2-7.	Operating Environment .....	2-4
2-8.	Storage .....	2-4
2-9.	Packaging .....	2-4
2-10.	Tagging for Service .....	2-4

## SECTION II Installation

### 2-1. Introduction

This section explains how to initially inspect the HP 16532A Oscilloscope Module, then how to prepare it for use, storage, and shipment. Also included are procedures for module installation.

### 2-2. Initial Inspection

Inspect the shipping container for damage. If the shipping container or cushioning material is damaged, it should be kept until the contents of the shipment have been checked for completeness and the module has been checked mechanically and electrically. The contents of the shipment should be as listed in the "Accessories Supplied" paragraph located in Section I.

Procedures for checking electrical performance are in Section III. If the contents of the container are incomplete, there is mechanical damage or defect, or the instrument does not pass the performance tests, notify the nearest Hewlett-Packard sales office.

If the shipping container is damaged, or the cushioning material shows signs of stress, notify the carrier as well as the Hewlett-Packard sales office. Keep the shipping material so the carrier can inspect it. The Hewlett-Packard office will arrange for repair or replacement at Hewlett-Packard's option without waiting for claim settlement.

### 2-3. Preparation for Use

#### WARNING

*Read the Safety Considerations in the front of this manual and in Section I before installing or operating this module.*

### 2-4. Power Requirements

All power supplies required for operating the HP 16532A Oscilloscope Module are supplied to the module through the backplane connector in the mainframe.

### 2-5. Safety Requirements

Specific warnings, cautions, and instructions are placed wherever applicable throughout the manual. These must be observed during all phases of operation, service, and repair of the module. Failure to comply with them violates safety standards of design, manufacture, and intended use of this module.

Hewlett-Packard assumes no liability for the failure of the customer to comply with these safety requirements.

### 2-6. Module Installation

#### CAUTION

*Do not install, remove, or replace the module in the instrument unless the instrument power is turned off.*

The HP 16532A Oscilloscope Module will take up one slot in the card cage. For every additional HP 16532A Oscilloscope Module you install, you will need an additional slot. They may be installed in any slot and in any order. The installation procedure for the module is continued, step-by-step, on the next page.

## Module Installation (cont.)

### CAUTION

*The effects of ELECTROSTATIC DISCHARGE can damage electronic components. Use grounded wrist straps and mats when you are performing any kind of service to this module.*

### Installation Considerations

- The HP 16532A Oscilloscope Modules can be installed in any available card slot.
- For multiple modules connected as one unit, the master card must be placed in the slot above the expander cards. The master card and expander cards must be in adjoining slots.
- Cards or filler panels below the empty slots intended for module installation do not have to be removed to install a module above them.

### Procedure:

1. Turn instrument power switch off, unplug power cord and disconnect any input connections.
2. Starting **from the top**, loosen the thumb screws on the filler panels and cards.
3. Starting **from the top**, begin pulling out the cards and filler panels **halfway**. See figure 2-1.

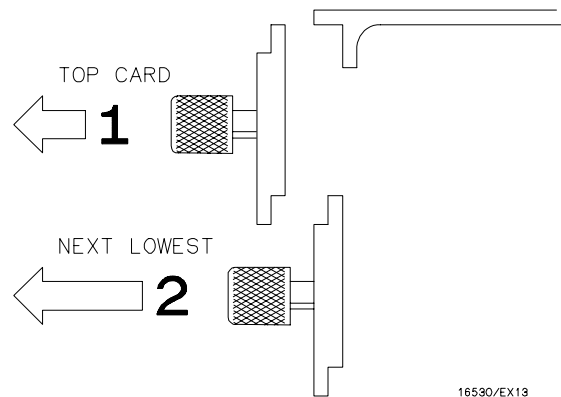
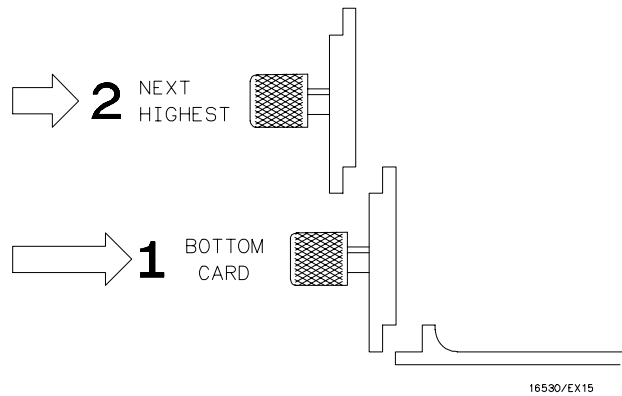

Figure 2-1. Endplate Overlap - Top Sequence

4. Slide the oscilloscope module into the card cage approximately halfway.
5. If you have more oscilloscope cards to install, slide them into the card cage approximately halfway.
6. Firmly seat the bottom card into the backplane connector. **Keep applying pressure to the center of the card endplate while tightening the thumb screws finger tight.**
7. Repeat step 6 for all cards and filler panels in a **bottom-to-top** order. See figure 2-2.
8. Any filler panels that are not used should be kept for future use. Filler panels **must** be installed in all unused card slots for correct air circulation.



*Figure 2-2. Endplate Overlap - Bottom Sequence*

## 2-7. Operating Environment

The operating environment is listed in table 1-2 of Section I of this manual. Note should be made of the non-condensing humidity limitation.

Condensation within the instrument can cause poor operation or malfunction. Protection should be provided against internal condensation.

The HP 16532A Oscilloscope Module will operate at all specifications within the temperature and humidity range given in table 1-2. However, reliability is enhanced when operating the module within the following ranges.

- **Temperature:** + 20 °C to + 35 °C (+ 68 °F to + 95 °F)
- **Humidity:** 20% to 80% non-condensing

## 2-8. Storage

The module may be stored or shipped in environments within the following limits:

- **Temperature:** – 40 °C to + 75 °C
- **Humidity:** Up to 90% at 65 °C
- **Altitude:** Up to 15,300 meters (50,000 feet)

The module should also be protected from temperature extremes which cause condensation on the instrument.

## 2-9. Packaging

The following general instructions should be used for repacking the module with commercially available materials.

- Wrap the module in antistatic plastic.
- Use a strong shipping container. A double-walled carton made of 350-lb test material is adequate.
- Use a layer of shock-absorbing material 70 to 100 mm (3- to 4-inch) thick around all sides of the module to provide firm cushioning and to prevent movement within the container.
- Seal the shipping container securely.
- Mark the shipping container FRAGILE to ensure proper handling.
- In any correspondence, refer to the module by its model number and serial number.

## 2-10. Tagging for Service

If the module is to be shipped to a Hewlett-Packard sales office for service or repair, attach a tag showing owner (with address), complete serial number, and a description of the service required.

# TABLE OF CONTENTS

## Performance Tests

3-1. Introduction .....	3-1
3-2. Recommended Test Equipment .....	3-1
3-3. Test Record .....	3-1
3-4. Performance Test Interval .....	3-1
3-5. Performance Test Procedures .....	3-1
3-6. DC CAL OUTPUT Test .....	3-2
3-7. AC CAL OUTPUT Test .....	3-3
3-8. Input Resistance .....	3-4
3-9. Voltage Measurement Accuracy .....	3-6
3-10. Offset Accuracy .....	3-9
3-11. Bandwidth .....	3-11
3-12. Time Measurement Accuracy.....	3-13
3-13. Trigger Sensitivity .....	3-15

## SECTION III

# Performance Tests

### 3-1. Introduction

The procedures in this section test the oscilloscope module's electrical performance using the specifications listed in Section I as the performance standards. All tests can be performed without access to the interior of the instrument. At the end of this section is a form that can be used as a record of performance test results.

### 3-2. Recommended Test Equipment

Equipment recommended for performance tests is listed in table 1-3. Any equipment that satisfies the critical specifications given in the table may be substituted for the recommended models.

### 3-3. Test Record

Results of performance tests may be tabulated on the Performance Test Record (table 3-1) at the end of the procedures. The test record lists all of the tested specifications and their acceptable limits.

The results recorded on the test record may be used for comparison in periodic maintenance and troubleshooting or after repairs and adjustments have been made.

### 3-4. Performance Test Interval

Periodic performance verification of the HP 16532A Oscilloscope Module is required at one-year intervals. The instrument's performance should be verified after it has been serviced, or if improper operation is suspected. Calibration should be performed before any performance verification checks.

### 3-5. Performance Test Procedures

All performance tests should be performed at the environmental operating temperature of the instrument, after a 30-minute warmup period.

### 3-6. DC CAL OUTPUT Test

The DC CAL OUTPUT port on the rear panel is used for instrument calibration and probe calibration. Though calibrator accuracy is not specified in the performance specifications, it must be within limits in order to provide accurate calibration.

**Test Limits:**

5.000 V ± 10 mV

**Equipment Required:**

The following equipment is required for the test.

Equipment Required	Critical Specification	Recommended Model/Part Number
Digital Multimeter	0.1 mV resolution, better than 0.005% accuracy	HP 3458A
Cable	50 Ω BNC (m to m) 48-inch	HP 10503A
Adapter	50 Ω BNC (f) to Dual Banana Plug	HP 1251-2277

**Procedure:**

1. Use the BNC-to-banana adapter to connect the BNC cable between the multimeter and the oscilloscope module DC CAL OUTPUT connector.
2. On the oscilloscope module set the following parameters in the order given:

Menu	Selection	Setting
Calibration	Mode Procedure DC Volts	Service Calibration DC Cal BNC 0 V

3. The DVM should read close to 0.0000 V. Record the reading to four decimal places.  
V1 = \_\_\_\_\_ .
4. In the Calibration menu set the DC Volts to 5 V.
5. The DVM should read close to 5.0000 V. Record the reading to four decimal places.  
V2 = \_\_\_\_\_ .
6. In the Calibration menu set the DC Volts to 0 V.
7. Subtract V1 from V2. The difference should be between 4.990 and 5.010 V. Record the reading in the performance test record.



### 3-7. AC CAL OUTPUT Test

The AC CAL OUTPUT port on the rear panel is used for instrument calibration and probe compensation. Though calibrator accuracy is not specified in the performance specifications, it must be within limits in order to provide accurate calibration.

#### Test Limits:

1000 Hz  $\pm$  10%, 0.8 V<sub>p-p</sub>  $\pm$  10%

#### Equipment Required:

The following equipment is required for the test.

Equipment Required	Critical Specification	Recommended Model/Part Number
Cable	50 $\Omega$ BNC (m to m) 48-inch	HP 10503A

#### Procedure:

1. Use the BNC cable to connect the AC CAL OUTPUT to channel 1 input of the oscilloscope module.
2. On the oscilloscope module set the following parameters in the order given:

Menu	Selection	Setting
Calibration	Mode	Service Calibration
	Procedure	Oscillator Output
	Signal	Probe Compensation
Channel	Coupling	1 M $\Omega$ /DC
	Probe	1:1

3. In the Calibration menu select AUTOSCALE.
4. In the Auto-Measure menu verify that the waveform is approximately 0.8 V<sub>p-p</sub> at approximately 1000 Hz. Record the reading in the performance test record.

### 3-8. INPUT RESISTANCE

This test verifies the input resistance of the oscilloscope module. A four-wire measurement is used for accuracy at 50  $\Omega$ .

#### Specification:

1 M  $\Omega$   $\pm$  1% and 50  $\Omega$   $\pm$  1%

#### Equipment Required:

The following equipment is required for the test. Procedures are based on the model or part numbers recommended.

Equipment Required	Critical Specification	Recommended Model/Part Number
Digital Multimeter	Measure resistance (4-wire) better than 0.25% accuracy	HP 3458A
Cables (2)	50 $\Omega$ BNC (m to m) 48-inch	HP 10503A
Adapter	50 $\Omega$ BNC Tee (m)(f)(f)	HP 1250-0781
Adapters (2)	50 $\Omega$ BNC (f) to Dual Banana Plug	HP 1251-2277

#### Procedure:

1. Set up the multimeter to make a 4-wire resistance measurement.
2. Use the BNC-to-banana adapters to connect one end of each BNC cable to the 4-wire resistance connections on the multimeter, and connect the free ends of the cables to the BNC Tee.
3. Connect the male end of the BNC tee to the channel 1 input of the oscilloscope module. Set up the oscilloscope module according to the following parameters in the order given:

Menu	Selection	Setting
Channel	Input Probe V/Div Offset Coupling	1 1:1 20 mV 0 V 50 $\Omega$ / DC
Trigger	Mode	Immediate

4. Select RUN - SINGLE. The clicking of attenuator relays should be audible. Verify resistance readings on the digital multimeter of  $50 \Omega \pm 0.5 \Omega$  (49.5 to 50.5  $\Omega$ ).
5. In the Channel menu change the Coupling field to 1 M $\Omega$ /DC.
6. Select RUN. The clicking of attenuator relays should be audible. Verify resistance readings on the digital multimeter of  $1 \text{ M}\Omega \pm 10 \text{ k}\Omega$  (0.990 to 1.010 M $\Omega$ ).
7. In the Channel menu change the Coupling field to 50  $\Omega$ /DC and V/Div to 200 mV/Div. Repeat steps 4 through 6.
8. In the Channel menu change the Coupling field to 50  $\Omega$  /DC and V/Div to 1 V/Div. Repeat steps 4 through 6.
9. In the Channel menu change the Coupling field to 50  $\Omega$  /DC and V/Div to 4 V/Div. Repeat steps 4 through 6.
10. Connect the male end of the BNC tee to the channel 2 input of the oscilloscope module.
11. Repeat steps 3 through 9 for channel 2, replacing channel 1 with channel 2 where applicable.

### **Note**

*If a reading is not within limits, then the attenuator for the out-of-bounds channel should be replaced. See "Service" in Section VI.*

### 3-9. VOLTAGE MEASUREMENT ACCURACY

This test verifies the DC voltage measurement accuracy of the instrument. This procedure uses a dual cursor measurement that nullifies offset error, resulting in the following measurement:

$\pm [(1.5\% \text{ of full scale}) + (0.016 \times \text{V/div})]$ .

**Specification:**

$\pm [(1.5\% \text{ of full scale} + \text{ offset accuracy}) + (0.008 \times \text{V/div})]$

**Equipment Required:**

The following equipment is required for this test. Procedures are based on the model or part numbers recommended.

Equipment Required	Critical Specification	Recommended Model/Part Number
DC Power Supply	-14 Vdc to + 14 Vdc, 0.1 mV resolution	HP 6114A
Digital Multimeter	Better than 0.1% accuracy	HP 3458A
Cable	50 $\Omega$ BNC (m to m) 48-inch	HP 10503A
Adapter (cable to power supply)	50 $\Omega$ BNC (f) to Dual Banana Plug	HP 1251-2277
Adapter	50 $\Omega$ BNC tee (m)(f)(f)	HP 1250-0781
Blocking Capacitor	50 $\Omega$ BNC (m to f) 0.18 $\mu$ F, 200 V	HP 10240B

**Procedure:**

1. Using a BNC adapter, connect one end of the cable to the power supply. Connect the BNC tee, the blocking capacitor, and the shorting endcap to the other end of the cable. Refer to figure 3-1.

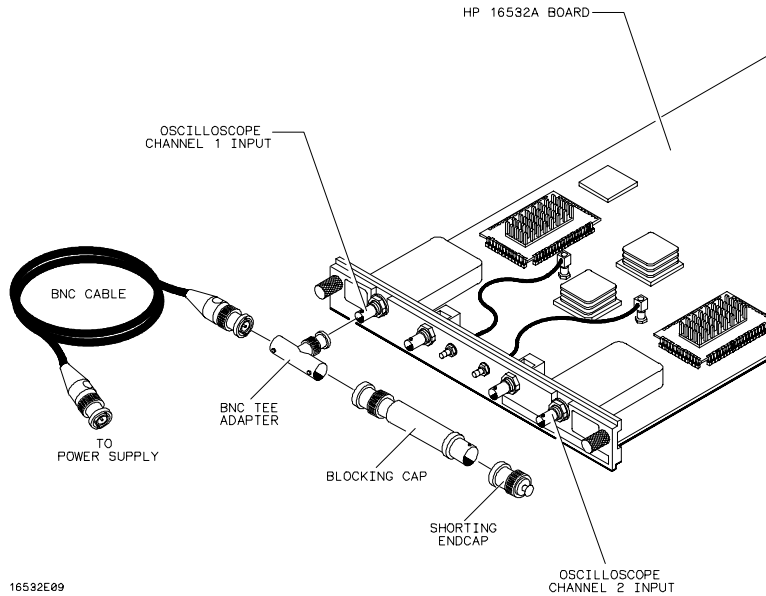

Figure 3-1. Voltage Measurement Accuracy Test

2. In the Waveform Selection menu delete channel 2. If channel 1 is not inserted, insert channel 1. Set the following parameters in the order given.

Menu	Selection	Setting
Channel	Input Probe Coupling s/Div	1 1:1 1 MΩ / DC 500 ns
Trigger	Mode	Immediate
Display	Mode Average # Grid Markers	Average 8 On On

**CAUTION**

Set the Channel **Coupling** field to 1 MΩ/DC or damage to the equipment will result.

Use the following table for steps 3 through 9.

V/Div	Offset	Supply	Upper Limit	Lower Limit
4 V/Div	-7.0 V	-14.0 V	-13.7 V	-14.3 V
1 V/Div	-1.75 V	-3.50 V	-3.43 V	-3.57 V
400 mV/Div	-700.0 mV	-1.40 V	-1.37 V	-1.43 V
40 mV/Div	-70.0 mV	-140.0 mV	-137.0 mV	-143.0 mV
40 mV/Div	70.0 mV	140.0 mV	143.0 mV	137.0 mV
400 mV/Div	700.0 mV	1.40 V	1.43 V	1.37 V
1 V/Div	1.75 V	3.50 V	3.57 V	3.43 V
4 V/Div	7.0 V	14.0 V	14.3 V	13.7 V

3. With the power supply disconnected from the channel input, set the Channel menu to the V/Div range and offset values shown in the first line of the table.
4. On the oscilloscope, select RUN - REPETITIVE and wait for approximately five seconds, then select STOP. Read the voltage displayed under the channel label on the left of the display. Enter this value on the performance test record in the "Zero Input" column.
5. Set the power supply to the first supply value listed in the table. Connect the power supply to the channel input as shown in figure 3-1.
6. On the oscilloscope, select RUN - REPETITIVE and wait for approximately five seconds, then select STOP. Read the voltage displayed under the channel label on the left of the display. Enter this value on the performance test record in the "Measured" column.
7. To obtain the test results, subtract the Zero Input voltage from the Measured voltage listed in the performance test record. For example:  $(\text{Measured}) - (\text{Zero Input}) = (\text{Actual})$ . When calculating the results, observe the plus or minus value of the voltage measurements. Record the results in the performance test record in the "Actual" column.
8. Repeat steps 3 through 8 for the second line of the table, then for the rest of the lines of the table for channel 1.
9. In the Waveform Selection menu, select Input channel 2. Delete channel 1 and insert channel 2. Repeat steps 2 through 8 for channel 2, replacing channel 1 with channel 2 where applicable.

### 3-10. OFFSET ACCURACY

This test verifies the offset accuracy.

#### Specification:

$\pm$  (1.0% of channel offset + 2.0% of full scale)

#### Equipment Required:

The following equipment is required for the test. Procedures are based on the model or part numbers recommended.

Equipment Required	Critical Specification	Recommended Model/Part Number
DC Power Supply	- 35.000 to + 35.000 Vdc, $\pm$ 1 mV resolution	HP 6114A
Digital Multimeter	Better than 0.1% accuracy	HP 3458A
Cable	50 $\Omega$ BNC (m to m) 48-inch	HP 10503A
Adapter	50 $\Omega$ BNC (f) to Dual Banana Plug	HP 1251-2277

#### Procedure:

##### Zero-Input Offset

1. Disconnect all cables and probes from the oscilloscope inputs. In the Waveform Selection menu delete channel 2. If channel 1 is not inserted, insert channel 1. Then set up the oscilloscope module according to the following parameters in the order given:

Menu	Selection	Setting
Channel	Input Probe v/Div Offset Coupling s/Div	1 1:1 4 V 0 V 1 M $\Omega$ / DC 500 ns
Trigger	Mode	Immediate
Display	Mode Average # Grid Markers	Average 32 On On

2. With the DC power supply disconnected from the channel input, make sure the markers are near the center of the display.

3. Select RUN - REPETITIVE. Wait approximately 15 seconds (averaging complete), then select STOP. The display should read  $0.00\text{ V} \pm 320.0\text{ mV}$  as read from the markers voltage field. Record the reading in the performance test record.
4. In the Channel menu, change the vertical sensitivity to 1 V/Div. Select RUN - REPETITIVE and wait approximately 15 seconds (averaging complete), then select STOP. The display should read  $0.00\text{ V} \pm 80.0\text{ mV}$ . Record the reading in the performance test record.
5. In the Channel menu, change the vertical sensitivity to 100 mV/Div. Select RUN - REPETITIVE and wait approximately 15 seconds (averaging complete), then select STOP. The display should read  $0.00\text{ V} \pm 8.0\text{ mV}$ . Record the reading in the performance test record.
6. In the Channel menu, change the vertical sensitivity to 10 mV/Div. Select RUN - REPETITIVE and wait approximately 15 seconds (averaging complete), then select STOP. The display should read  $0.00\text{ V} \pm 800.0\text{ }\mu\text{V}$ . Record the reading in the performance test record.

**DC Input Offset**



*Set the Channel **Coupling** field to  $1\text{M}\Omega$  / DC or damage to the equipment will result.*

7. Use the BNC-to-banana adapter to connect the BNC cable between the power supply and channel 1 input. Monitor the power supply using a voltmeter.
8. Use the following table for the next steps:

V/Div	Offset	Supply	Min	Max
1 V/Div	- 35.00 V	- 35.00 V	- 35.4 V	- 34.6 V
100 mV/Div	- 10.00 V	- 10.00 V	- 10.1 V	- 9.90 V
20 mV/Div	- 2.00 V	- 2.00 V	- 2.02 V	- 1.98 V
20 mV/Div	+ 2.00 V	+ 2.00 V	+ 1.98 V	+ 2.02 V
100 mV/Div	+ 10.00 V	+ 10.00 V	+ 9.90 V	+ 10.1 V
1 V/Div	+ 35.00 V	+ 35.00 V	+ 34.6 V	+ 35.4 V

9. In the Channel menu set the V/Div range and offset per the first line of the table. Set the power supply per the first line of the table.
10. On the oscilloscope, select RUN - REPETITIVE and wait approximately 15 seconds (averaging complete), then STOP.
11. Read the voltage from the markers voltage field. It should be within the limits given in the table. Record the reading in the performance test record.
12. Repeat steps 7 through 10 for the remaining lines of the table using the V/Div range, offset, and supply voltages given in the table.
13. In the Channel menu select channel 2. In the Waveform Selection menu delete channel 1 and insert channel 2.
14. Repeat steps 1 through 12 for channel 2, replacing channel 1 with channel 2 where applicable.



### 3-11. BANDWIDTH

This test checks the bandwidth of the oscilloscope module.

#### Specification:

Bandwidth (dc coupled) dc to 250 MHz

#### Equipment Required:

The following equipment is required for this test. Procedures are based on the model or part number recommended.

Equipment Required	Critical Specification	Recommended Model/Part Number
Signal Generator	1 - 250 MHz at approx 170 mVrms	HP 8656B
Power Meter/Sensor	1 - 250 MHz $\pm$ 3% accuracy	HP 436/8482A
Power Splitter	Outputs differ by < 0.15 dB	HP 11667B
Cable	Type N (m to m) 24-inch	HP 11500B
Adapter	50 $\Omega$ Type N (m) to BNC (m)	HP 1250-0082

#### Procedure:

1. With the N cable, connect the signal generator to the power splitter input. Connect the power sensor to one output of the power splitter.
2. Using an N-to-BNC adapter, connect the other power splitter output to the Channel 1 input of the oscilloscope module.
3. In the **Waveform Selection** menu delete channel 2. If channel 1 is not inserted, insert channel 1. Set the following parameters.

Menu	Selection	Setting
Channel	Input Probe v/Div Offset Coupling s/Div	1 1:1 80 mV 0 V 50 $\Omega$ / DC 200 ns
Trigger	Mode Level	Edge 0 V
Display	Mode Average # Grid Markers	Average 32 On Off

4. Set the signal generator for 1MHz at – 2.4 dBm. On the oscilloscope, select RUN - REPETITIVE. The signal on the screen should be two cycles at three divisions amplitude.
5. After the measurement settles (averaging complete, about 15 seconds), select STOP. In the Auto-Measure menu note the  $V_{p-p}$  reading.  $V_{1MHz} = \underline{\hspace{2cm}}$  mV.
6. Set the power meter Cal Factor % to the 1MHz value from the calibration chart on the power splitter. Then press dB[REF] to set a 0 dB reference.
7. Change the signal generator to 250 MHz. Set power meter Cal Factor % to the 250 MHz value from the chart.
8. Adjust the signal generator amplitude for a power reading as close as possible to 0.0 dB[REL]. Reading =  $\underline{\hspace{2cm}}$  dB.
9. Set the oscilloscope s/Div for 2 ns/Div and select RUN-REPETITIVE.
10. After the measurement settles (averaging complete), select STOP. In the Auto-Measure menu note the  $V_{p-p}$  reading.  $V_{250MHz} = \underline{\hspace{2cm}}$  mV.
11. Calculate the response using the formula:

$$response (dB) = 20 \log_{10} \frac{V_{250Mhz}}{V_{1MHz}} = 20 \log_{10} (\underline{\hspace{2cm}}) = \underline{\hspace{2cm}} dB$$

12. Correct the result from step 11 with any differences in the power meter from step 8. Observe signs. For example:

Result from step 11 = – 2.3 dB  
 Power meter reading = – 0.2 dB[REL]  
 then true response = (– 2.3) – (– 0.2) – 2.1dB

$$(\underline{\hspace{2cm}}) - (\underline{\hspace{2cm}}) = \underline{\hspace{2cm}} dB$$

13. The result from step 12 should be  $\leq -3.0$  dB. Record the result in the Performance Test Record.
14. In the **Channel** menu select channel 2. In the **Waveform Selection** menu delete channel 1 and insert channel 2.
15. Repeat steps 2 through 14 for channel 2, replacing channel 1 with channel 2 where applicable.

**Note**

*Failure of the bandwidth test can be caused by a faulty attenuator or main assembly.*

### 3-12. TIME MEASUREMENT ACCURACY

This test uses a precise frequency source to check the accuracy of time measurement functions.

#### Specification:

$$\pm [(0.005\% \times \Delta t) + (2 \times 10^{-6} \times \text{delay setting}) + 150 \text{ ps}]$$

#### Equipment Required:

The following equipment is required for this test. Procedures are based on the model or part number recommended.

Equipment Required	Critical Specification	Recommended Model/Part Number
Signal Generator	200 MHz, timebase accuracy 0.25 ppm	HP 8656B Opt. 001
Cable	50 $\Omega$ BNC (m to m) 48-inch	HP 10503A
Adapter	50 $\Omega$ Type N (m) to BNC (f)	HP 1250-0780

#### Procedure:

1. Set the signal generator to 181.81818 MHz (5.5 ns period) and approximately 600 mV rms.
2. Use the N-to-BNC adapter to connect the cable to the signal generator. Connect the free end of the BNC cable to the channel 1 input.
3. In the Waveform Selection menu delete channel 2. If channel 1 is not inserted, insert channel 1. Set the following parameters in the order given:

Menu	Selection	Setting
Channel	Input Probe v/Div Offset Coupling s/Div	1 1:1 400 mV 0.0 V 50 $\Omega$ / DC 2.00 ns
Trigger	Mode Source Level Slope	Edge Chan 1 0.0 V Positive
Display	Mode Grid	Normal On

4. Select the Markers Auto menu, and set the following parameters:

Menu	Selection	Setting
Markers Auto	X→	Set on chan 1 at Level 50% Slope Positive Occur 1
	O→	Set on chan 1 at Level 50% Slope Positive Occur 2
	Statistics	On

5. Select DONE. On the oscilloscope module select RUN - REPETITIVE. If the waveform is clipping, reduce the signal generator output voltage level until the waveform no longer clips. Allow the oscilloscope module to run approximately two minutes, then select STOP.
6. In the statistics field, check to see that the MEAN X-O field is approximately 5.500 ns. Check that both the MIN X-O and the MAX X-O are within 150 ps of the MEAN X-O. Record the results in the performance test record.
7. Select the Markers Auto menu, and set the following parameters:

Menu	Selection	Setting
Markers Auto	X→	Manual
	O→	Set on chan 1 at Level 50% Slope Positive Occur 1
	Statistics	On

8. Select DONE. In the Display menu, set MODE AVERAGE # 8 and DELAY 99.00 ns. Select RUN-REPETITIVE and allow the oscilloscope module to run approximately two minutes. Select STOP.
9. In the statistics field, check to see that the MEAN X-O field is approximately 99.000 ns. Check that both the MIN X-O and the MAX X-O are within 155 ps of the MEAN X-O. Record the results in the performance test record.

**Note**

*Failure of the time measurement accuracy test can be caused by a defective main assembly.*

### 3-13. TRIGGER SENSITIVITY

This test checks channel triggers for sensitivity at rated bandwidth.

#### Specification:

dc to 50 MHz : 0.063 x full scale (0.25 division)  
50 to 250 MHz : 0.125 x full scale (0.5 division)

#### Equipment Required:

The following equipment is required for this test. Procedures are based on the model or part number recommended.

Equipment Required	Critical Specification	Recommended Model/Part Number
Signal Generator	50 and 250 MHz, 30-80 mV <sub>rms</sub> output	HP 8656B Opt. 001
Cable	50 Ω BNC 48-inch	HP 10503B
Adapter	50 Ω Type N (m) to BNC (f)	HP 1250-0780

#### Procedure:

1. In the Waveform Selection menu delete channel 2. If channel 1 is not inserted, insert channel 1. On the oscilloscope module set the following parameters in the order given:

Menu	Selection	Setting
Channel	Input Probe v/Div Offset Coupling s/Div	1 1:1 400 mV 0 V 50 Ω / DC 20 ns
Trigger	Mode Source Level	Edge Chan 1 0 V
Display	Mode Average # Grid Markers	Average 8 On Off

2. With an N-to-BNC adapter and BNC cable, connect the signal generator to channel 1 input.

3. Set the signal generator for a 50 MHz and 35 mV rms signal. On the oscilloscope module select RUN - REPETITIVE.
4. In the **Auto-Measure** menu read  $V_{p-p}$ . Adjust the signal generator output level so that the signal is close to and not more than 100 mV<sub>p-p</sub>.
5. In the **Trigger** menu adjust the trigger level for a stable display. The test passes if the trigger is stable. Record whether the trigger is stable or is not stable.
6. On the oscilloscope module select STOP. Set the signal generator frequency to 250 MHz and 70 mV rms signal level.
7. In the **Channel** menu change s/Div to 5 ns/Div and select RUN.
8. In the **Auto-Measure** menu read  $V_{p-p}$ . Adjust the signal generator output level so that the signal is close to and not more than 200 mV<sub>p-p</sub>.
9. In the **Trigger** menu adjust the trigger level for a stable display. The test passes if the trigger is stable. Record whether the trigger is stable or is not stable in the performance test record.
10. On the oscilloscope module select STOP. In the **Channel** menu select channel 2. In the **Trigger** menu select Source channel 2. In the **Waveform Selection** menu delete channel 1 and insert channel 2.
11. Repeat steps 1 through 9 for channel 2, replacing channel 1 with channel 2 where applicable.

### Note

*Failure of the trigger sensitivity test can be caused by a defective main assembly.*

Table 3-1. Performance Test Record

Hewlett-Packard Model 16532A Oscilloscope Module Serial No.: _____	Recommended Performance Verification Interval: <u>12</u> Months	Tested by _____ Work Order No. _____ Date Tested _____		
<u>Paragraph No.</u>	<u>Test</u>	<u>Results</u>		
3-6	DC CAL OUTPUT 5.000Vdc ± 10mV	Minimum 4.990Vdc	Maximum 5.010Vdc	Actual _____Vdc
3-7	AC CAL OUTPUT 0.8Vp_p ± 10% 1000Hz ± 10%	Minimum 0.72Vp_p  Minimum 900Hz	Maximum 0.88Vp_p  Maximum 1100Hz	Actual _____Vp_p  Actual _____Hz
3-8	Input Resistance 50Ω ± 0.5Ω (49.5 to 50.5Ω) 1MΩ ± 10KΩ (0.990 to 1.010MΩ)	Channel 1 Reading 50Ω @ 20mV/Div _____ Ω 1MΩ @ 20mV/Div _____ Ω 50Ω @ 200mV/Div _____ Ω 1MΩ @ 200mV/Div _____ Ω 50Ω @ 1V/Div _____ Ω 1MΩ @ 1V/Div _____ Ω 50Ω @ 4V/Div _____ Ω 1MΩ @ 4V/Div _____ Ω  Channel 2 Reading 50Ω @ 20mV/Div _____ Ω 1MΩ @ 20mV/Div _____ Ω 50Ω @ 200mV/Div _____ Ω 1MΩ @ 200mV/Div _____ Ω 50Ω @ 1V/Div _____ Ω 1MΩ @ 1V/Div _____ Ω 50Ω @ 4V/Div _____ Ω 1MΩ @ 4V/Div _____ Ω		
3-9	Voltage Measurement Accuracy  Upper Limit      Lower Limit  -13.7V              -14.3V -3.43V              -3.57V -1.37V              -1.43V -137.0mV          -143.0mV 143.0mV            137.0mV 1.43V                1.37V 3.57V                3.43V 14.3V                13.7V	Channel 1 Zero Input      Measured      Actual _____      _____      _____V _____      _____      _____V _____      _____      _____V _____      _____      _____mV _____      _____      _____mV _____      _____      _____V _____      _____      _____V _____      _____      _____V		

Table 3-1. Performance Test Record (Continued)

Paragraph No.	Test	Results																																																																																								
3-9	Voltage Measurement Accuracy (continued) Upper Limit      Lower Limit -13.7V            -14.3V -3.43V           -3.57V -1.37V           -1.43V -137.0mV       -143.0mV 143.0mV        137.0mV 1.43V            1.37V 3.57V            3.43V 14.3V            13.7V	Channel 2 Zero Input      Measured      Actual _____      _____      _____ V _____      _____      _____ V _____      _____      _____ V _____      _____      _____ mV _____      _____      _____ mV _____      _____      _____ V _____      _____      _____ V _____      _____      _____ V																																																																																								
3-10	Offset Accuracy Zero-input Offset-Channel 1  Offset Accuracy DC Input Offset-Channel 1  Offset Accuracy Zero-input Offset-Channel 2  Offset Accuracy DC Input Offset-Channel 2	<table border="0"> <tr> <td>V/Div Setting</td> <td>Reading</td> <td>Actual</td> </tr> <tr> <td>4V/Div</td> <td>0.00V± 320.0mV</td> <td>_____ V</td> </tr> <tr> <td>1V/Div</td> <td>0.00V± 80.0mV</td> <td>_____ V</td> </tr> <tr> <td>100mV/Div</td> <td>0.00V± 8.0mV</td> <td>_____ V</td> </tr> <tr> <td>10mV/Div</td> <td>0.00V± 800.0µV</td> <td>_____ V</td> </tr> </table> <table border="0"> <tr> <td>Supply</td> <td>Min</td> <td>Max</td> <td>Actual</td> </tr> <tr> <td>-35.00V</td> <td>-35.4V</td> <td>-34.6V</td> <td>- _____ V</td> </tr> <tr> <td>-10.00V</td> <td>-10.1V</td> <td>-9.90V</td> <td>- _____ V</td> </tr> <tr> <td>-2.00V</td> <td>-2.02V</td> <td>-1.98V</td> <td>- _____ V</td> </tr> <tr> <td>+2.00V</td> <td>+1.98V</td> <td>+2.02V</td> <td>+ _____ V</td> </tr> <tr> <td>+10.00V</td> <td>+9.90V</td> <td>+10.1V</td> <td>+ _____ V</td> </tr> <tr> <td>+35.00V</td> <td>+34.6V</td> <td>+35.4V</td> <td>+ _____ V</td> </tr> </table> <table border="0"> <tr> <td>V/Div Setting</td> <td>Reading</td> <td>Actual</td> </tr> <tr> <td>4V/Div</td> <td>0.00V± 320.0mV</td> <td>_____ V</td> </tr> <tr> <td>1V/Div</td> <td>0.00V± 80.0mV</td> <td>_____ V</td> </tr> <tr> <td>100mV/Div</td> <td>0.00V± 8.0mV</td> <td>_____ V</td> </tr> <tr> <td>10mV/Div</td> <td>0.00V± 800.0µV</td> <td>_____ V</td> </tr> </table> <table border="0"> <tr> <td>Supply</td> <td>Min</td> <td>Max</td> <td>Actual</td> </tr> <tr> <td>-35.00V</td> <td>-35.4V</td> <td>-34.6V</td> <td>- _____ V</td> </tr> <tr> <td>-10.00V</td> <td>-10.1V</td> <td>-9.90V</td> <td>- _____ V</td> </tr> <tr> <td>-2.00V</td> <td>-2.02V</td> <td>-1.98V</td> <td>- _____ V</td> </tr> <tr> <td>+2.00V</td> <td>+1.98V</td> <td>+2.02V</td> <td>+ _____ V</td> </tr> <tr> <td>+10.00V</td> <td>+9.90V</td> <td>+10.1V</td> <td>+ _____ V</td> </tr> <tr> <td>+35.00V</td> <td>+34.6V</td> <td>+35.4V</td> <td>+ _____ V</td> </tr> </table>			V/Div Setting	Reading	Actual	4V/Div	0.00V± 320.0mV	_____ V	1V/Div	0.00V± 80.0mV	_____ V	100mV/Div	0.00V± 8.0mV	_____ V	10mV/Div	0.00V± 800.0µV	_____ V	Supply	Min	Max	Actual	-35.00V	-35.4V	-34.6V	- _____ V	-10.00V	-10.1V	-9.90V	- _____ V	-2.00V	-2.02V	-1.98V	- _____ V	+2.00V	+1.98V	+2.02V	+ _____ V	+10.00V	+9.90V	+10.1V	+ _____ V	+35.00V	+34.6V	+35.4V	+ _____ V	V/Div Setting	Reading	Actual	4V/Div	0.00V± 320.0mV	_____ V	1V/Div	0.00V± 80.0mV	_____ V	100mV/Div	0.00V± 8.0mV	_____ V	10mV/Div	0.00V± 800.0µV	_____ V	Supply	Min	Max	Actual	-35.00V	-35.4V	-34.6V	- _____ V	-10.00V	-10.1V	-9.90V	- _____ V	-2.00V	-2.02V	-1.98V	- _____ V	+2.00V	+1.98V	+2.02V	+ _____ V	+10.00V	+9.90V	+10.1V	+ _____ V	+35.00V	+34.6V	+35.4V	+ _____ V
V/Div Setting	Reading	Actual																																																																																								
4V/Div	0.00V± 320.0mV	_____ V																																																																																								
1V/Div	0.00V± 80.0mV	_____ V																																																																																								
100mV/Div	0.00V± 8.0mV	_____ V																																																																																								
10mV/Div	0.00V± 800.0µV	_____ V																																																																																								
Supply	Min	Max	Actual																																																																																							
-35.00V	-35.4V	-34.6V	- _____ V																																																																																							
-10.00V	-10.1V	-9.90V	- _____ V																																																																																							
-2.00V	-2.02V	-1.98V	- _____ V																																																																																							
+2.00V	+1.98V	+2.02V	+ _____ V																																																																																							
+10.00V	+9.90V	+10.1V	+ _____ V																																																																																							
+35.00V	+34.6V	+35.4V	+ _____ V																																																																																							
V/Div Setting	Reading	Actual																																																																																								
4V/Div	0.00V± 320.0mV	_____ V																																																																																								
1V/Div	0.00V± 80.0mV	_____ V																																																																																								
100mV/Div	0.00V± 8.0mV	_____ V																																																																																								
10mV/Div	0.00V± 800.0µV	_____ V																																																																																								
Supply	Min	Max	Actual																																																																																							
-35.00V	-35.4V	-34.6V	- _____ V																																																																																							
-10.00V	-10.1V	-9.90V	- _____ V																																																																																							
-2.00V	-2.02V	-1.98V	- _____ V																																																																																							
+2.00V	+1.98V	+2.02V	+ _____ V																																																																																							
+10.00V	+9.90V	+10.1V	+ _____ V																																																																																							
+35.00V	+34.6V	+35.4V	+ _____ V																																																																																							
3-11	Bandwidth $\leq -3.0\text{dB}$	Channel 1: Actual Reading= _____ dB  Channel 2: Actual Reading = _____ dB																																																																																								



Table 3-1. Performance Test Record (Continued)

<u>Paragraph No.</u>	<u>Test</u>	<u>Results</u>
3-12	Time Measurement Accuracy 5.500ns ± 150ps  99.00ns ± 155ps	MEAN X-0 _____ns MIN X-0 _____ns MEAN X-0 - MIN X-0 = _____ps MAX X-0 _____ns MAX X-0 - MEAN X-0 = _____ps  MEAN X-0 _____ns MIN X-0 _____ns MEAN X-0 - MIN X-0 = _____ps MAX X-0 _____ns MAX X-0 - MEAN X-0 = _____ps
3-13	Trigger Sensitivity	Channel 1: Trigger Stable @ 100mVp_p Yes ___ No ___ Trigger Stable @ 200mVp_p Yes ___ No ___  Channel 2: Trigger Stable @ 100mVp_p Yes ___ No ___ Trigger Stable @ 200mVp_p Yes ___ No ___

## TABLE OF CONTENTS

### Calibration

4-1.	Introduction.....	4-1
4-2.	Safety Requirements.....	4-1
4-3.	Calibration Interval.....	4-1
4-4.	Maintaining System Integrity.....	4-1
4-5.	Calibration Protection Switch.....	4-1
4-6.	Recommended Test Equipment.....	4-2
4-7.	Instrument Warmup.....	4-2
4-8.	Calibration.....	4-2
4-9.	Setting the PROTECT/UNPROTECT Switch to UNPROTECT.....	4-3
4-10.	Equipment Required for Calibration.....	4-4
4-11.	Loading the Default Calibration Factors.....	4-4
4-12.	Self Cal Menu Calibrations.....	4-5
4-13.	Setting the PROTECT/UNPROTECT Switch to PROTECT.....	4-8
4-14.	Sealing the Mainframe.....	4-8

## SECTION IV Calibration

### 4-1. Introduction

This section provides information on calibrating the HP 16532A 1 GSa/s Oscilloscope module. Information is included about when to calibrate the module, the module warm up interval required prior to calibration, and how to do the actual calibration of the module. Also included are safety requirements to observe when working on the equipment, a list of recommended test equipment, and equipment setups for the different calibration procedures. Although the module has no hardware adjustments, it does contain a calibration PROTECT/UNPROTECT switch that you use before and after calibration. Actual calibration of the module is performed in software.

### 4-2. Safety Requirements

#### WARNING

*Read the safety summary at the front of this manual before any replacement, maintenance, or repair is performed.*

Specific warnings, cautions, and instructions are placed wherever applicable throughout the manual. These must be observed during all phases of operation, service, and repair of the module. Failure to comply with them violates safety standards of design, manufacture, and intended use of this module. Hewlett-Packard assumes no liability for the failure of the customer to comply with these safety requirements.

### 4-3. Calibration Interval

To maintain proper calibration, perform calibration at approximately six-month intervals, or every 1000 hours, when the instrument is being used under normal operating conditions. Immediate calibration is required if one of the following occurs:

- Oscilloscope module is installed, repaired, or replaced, or if the card slot configuration is changed.
- The oscilloscope software changes revision number and asterisks (\*) are on the calibration menu.
- Ambient temperature changes more than 10 °C.

If you add or delete a card(s) from a calibrated multicard oscilloscope module, you must perform the Time Null calibration.

### 4-4. Maintaining System Integrity

Calibration factors depend on the mainframe, module, and module configuration all staying together. If oscilloscope modules are interchanged between mainframes, or the oscilloscope module slot configuration is changed, calibration must be repeated. In an environment in which the possibility of sharing oscilloscope modules exists, Hewlett-Packard recommends taking the following precautions in order to maintain system integrity:

With the system turned off, place the PROTECT/UNPROTECT switch (all switches in a single or a chained, multiple oscilloscope module configuration) in the UNPROTECT position.

Boot the system and perform calibration for each module.

Turn off the system, place the PROTECT/UNPROTECT switch (all switches in a single or a chained, multiple oscilloscope module configuration) in the PROTECT position, then seal the mainframe.

### 4-5. Calibration Protection Switch

Each HP 16532A board stores the calibration factors for that board in non-volatile RAM on the board itself. The HP 16532A board contains a calibration protection (PROTECT/UNPROTECT) switch. With the switch in the PROTECT position, calibration values cannot be changed.

To run the scope calibration, the switch must be in the UNPROTECT position. When you have more than one HP 16532A board in a mainframe, this must be done for each one of the boards. After calibration is complete, all the switches must be set to the PROTECT position to save the calibration values. Also, all the modules or filler panels must be reinstalled in the mainframe, then a seal should be placed on the equipment such that the seal touches both the top-most module and the mainframe. This is done to assure that calibration integrity is maintained.

When ordered with a system, oscilloscope modules are calibrated at Hewlett-Packard as single units (not chained together). If you need to use the modules as one unit (chained together), perform the Time Null Calibration in section 4-12.

The calibration procedure sets the oscilloscope calibration factors and stores them in non-volatile RAM on the board. The procedures use signals generated in the oscilloscope module itself to calibrate channel sensitivity, offset, and trigger parameters. The calibration factors set up the module each time the instrument is turned on.

#### 4-6. Recommended Test Equipment

The only test equipment required for calibration are cables and adapters. These are listed in paragraph 4-10 and are called out in the applicable calibration procedure.

The calibration procedures in this section should be followed in their entirety and in the sequence listed in table 4-1. Though in this section the default calibrations are loaded before calibration, calibration can be done without loading them. However, if they are loaded, they should be loaded before an actual calibration is done.

#### 4-7. Instrument Warmup

Calibrate the oscilloscope module at its environmental ambient temperature, after a 30-minute warmup period of the HP 16500A/16501A mainframe with the module installed.

When calibrating the module, it must be installed in the mainframe, and the mainframe covers and filler panels must be in place. The module must be warmed up (refer to "Instrument Warmup" given earlier in this section).

#### 4-8. Calibration

This section provides software calibration procedures for the HP 16532A oscilloscope module. There are no hardware adjustments on the oscilloscope module. The calibration is performed without access to the interior of the instrument.

Calibration procedures require the use of cables and adapters only. Non-service personnel can perform the calibration, however, to do the calibration, it is necessary to unprotect the current calibration values. This may not be allowed in some circumstances – check with your Calibration Laboratory or Service Department before you attempt calibration. To perform calibration, follow the "Self Cal Menu Calibration" procedures given later in this section.

Table 4-1. Calibration Sequence

Sequence	Calibration	Paragraph
1	Set the PROTECT/UNPROTECT Switch to UNPROTECT	4-9
2	Default (Not required as part of the calibration procedures) Self Cal Menu	4-11
3	Vertical Calibration (all channels)	4-12
4	Delay Calibration– Channel 1	4-12
	Delay Calibration– Channel 2	4-12
5	Time Null Calibration (all channels)	4-12
6	Logic Trigger - Channel 1	4-12
7	External Trigger Null Calibration	4-12
8	Set the PROTECT/UNPROTECT Switch to PROTECT	4-13

## 4-9. Setting the PROTECT/UNPROTECT Switch to UNPROTECT

### CAUTION

*The effects of ELECTROSTATIC DISCHARGE can damage electronic components. Use grounded wrist straps and mats when you are performing any kind of service on this module.*

The oscilloscope board contains a calibration PROTECT/UNPROTECT switch. This switch must be set to UNPROTECT before calibration can be done. Set the switch to UNPROTECT as follows:

1. Remove power from the instrument. Pull halfway out all of the modules located above the oscilloscope and remove the filler panels and cards located above the oscilloscope. See figure 4-1 for the removal sequence.

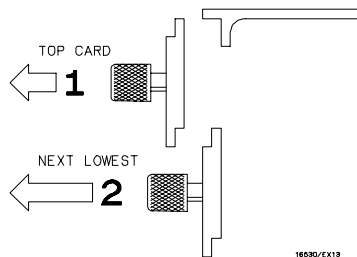

Figure 4-1. Endplate Overlap - Top Sequence

2. Remove the oscilloscope module and set the PROTECT/UNPROTECT switch to the UNPROTECT position. See Figure 4-2 to locate this switch.

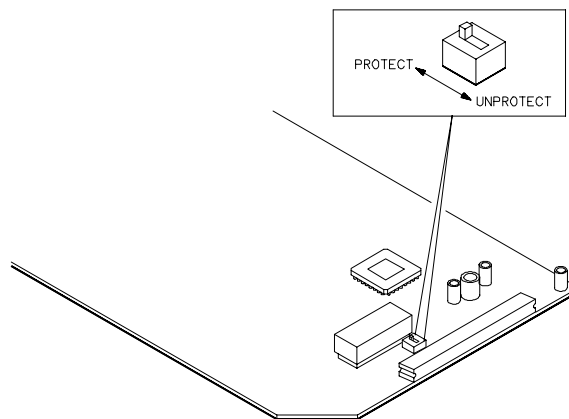

Figure 4-2. Location of the PROTECT/UNPROTECT Switch

3. Repeat step 2 for every oscilloscope module if this is a multimodule calibration.
4. Reinstall the modules and filler panels in reverse order of steps 1 and 2.

#### 4-10. Equipment Required for Calibration

The equipment listed below is required for calibration:

Cable (2)	50Ω BNC, 9-inch (equal length)	HP 10502A
Cable	50Ω BNC - SMB	HP 16532-61601
Adapter	50Ω BNC tee (m)(f)(f)	HP 1250-0781
Adapter	50Ω BNC (m)(m)	HP 1250-1236

#### 4-11. Loading the Default Calibration Factors



*Once the default calibration factors are loaded, all calibrations must be done. This includes all of the calibrations in the Self Cal menu. The calibration must be performed in the exact sequence listed in table 4-1.*

#### Note

*The calibration PROTECT/UNPROTECT switch on the oscilloscope board must be set to UNPROTECT.*

Load the default calibration factors as follows:

1. Touch the menu field (top row, second from the left), then select **Calibration** from the pop-up menu.
2. Touch the **Mode** field, then select **Service Cal** from the pop-up menu.
3. Touch the **Procedure** field, then select **Default Values** from the pop-up menu.

#### Note

*After you touch the Start field, you can abort the calibration procedure either by touching the Cancel field, if it is available in the menu, or by touching either the Mode or Procedure fields if the continue field is still displayed on the screen.*

4. Touch the **Start** field and follow the instructions on the display. The display should now look similar to the display shown in figure 4-3.

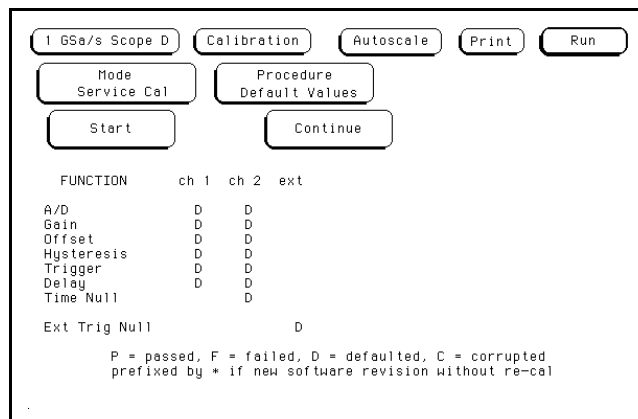

Figure 4-3. Default Calibration Display

## 4-12. Self Cal Menu Calibrations

### Note

*After you touch the Start field, you can abort the calibration procedure either by touching the Cancel field, if it is available in the menu, or by touching either the Mode or Procedure fields if the continue field is still displayed on the screen.*

Messages will be displayed as each calibration routine is completed to indicate calibration has passed or failed. The resulting calibration factors are automatically stored to nonvolatile RAM at the conclusion of each calibration routine.

The Self Cal menu lets you calibrate vertical sensitivity (Vert Cal) for channels 1 and 2 individually or both channels on a board simultaneously if it is a stand alone scope. Also, the Self Cal menu lets you calibrate delay (Delay) for channel 1 and 2 separately, then Time Null for each channel separately (except channel 1 of the master board), and Ext Trig Null for the external trigger (ECL).

### Calibrate Vert Cal of the Self Cal menu as follows:

1. Connect two BNC 50- $\Omega$ , 9-inch cables to the BNC tee adapter.

### Note

*When you touch Start, the instrument will prompt you to connect the cables to the appropriate locations on the rear panel of the module.*

2. Touch the **Mode** field, then select **Self Cal** from the pop-up menu.
3. Touch the **Procedure** field, then select **Vert Cal** from the pop-up menu.
4. Touch the **Channel** field, then select a channel choice from the pop-up menu.
5. Touch the **Start** field and follow the instructions on the display.
6. After completion of vertical calibration remove the cables from the rear panel of the oscilloscope.

### Calibrate Delay of the Self Cal menu as follows:

1. Obtain a BNC 50- $\Omega$ , 9-inch cable.

### Note

*When you touch Start, the instrument will prompt you to connect the cable to the appropriate location on the rear panel of the module.*

2. Touch the **Procedure** field, then select **Delay** from the pop-up menu.

3. Touch the **Channel** field, then select **S1** from the pop-up menu (where S is the slot letter where the oscilloscope module is installed in the mainframe).
4. Touch the **Start** field and follow the instructions on the display.
5. After completion of channel 1 delay calibration, remove the cable from the rear panel of the oscilloscope.
6. Repeat steps 3 through 5 for channel **S2**.
7. After completing all of the channel delay calibrations, remove the cable from the rear panel of the oscilloscope.

**Calibrate the Time Null of the Self Cal menu as follows:**

1. Connect two BNC 50- $\Omega$ , 9-inch cables to the BNC tee adapter.

**Note**

*When you touch Start, the instrument will prompt you to connect the cables to the appropriate locations on the rear panel of the module.*

2. Touch the **Procedure** field, then select **Time Null** from the pop-up menu.
3. Touch the **Channel** field, then select **S2** from the pop-up menu (where S is the slot letter where the oscilloscope module is installed in the mainframe).
4. Touch the **Start** field and follow the instructions on the display.
5. Repeat steps 3 through 4 for each channel, replacing **S2** with the appropriate channel number.
6. At the conclusion of the time null calibration, remove the cables from the rear of the module.

**Calibrate the Logic Trigger of the Self Cal menu as follows:**

1. Obtain one BNC 50  $\Omega$  9-inch cable.

**Note**

*When you touch Start, the instrument will prompt you to connect the cables to the appropriate locations on the rear panel of the module.*

2. Touch the **Procedure** field, then select **Logic Trigger** from the pop-up menu.
3. Touch the **Start** field, then follow the instructions on the display.
4. At the conclusion of the Logic Trigger calibration, remove the cable from the rear of the module.



**Calibrate the Ext Trig Null of the Self Cal menu as follows:**

1. Connect the cables, BNC adapter, and BNC tee adapter together as shown in figure 4-4.

**Note**

*When you touch Start, the instrument will prompt you to connect the cables to the appropriate locations on the rear panel of the module.*

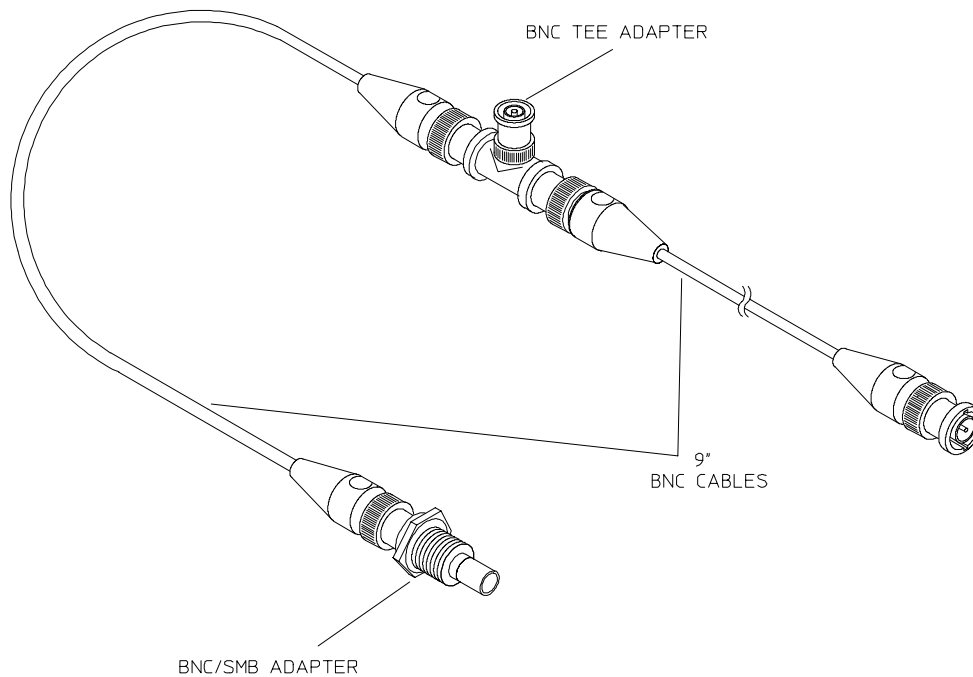

*Figure 4-4. Ext Trig Null Calibration Connections*

2. Touch the **Procedure** field, then select **Ext Trig Null** from the pop-up menu.
3. Touch the **Start** field and follow the instructions on the display.
4. At the conclusion of the ext trig null calibration, remove the cables from the rear of the module.

Messages will be displayed as each calibration routine is completed to indicate calibration has passed or failed. The resulting calibration factors are automatically stored to nonvolatile RAM at the conclusion of each calibration routine.

This is the conclusion of the calibration procedures. The display should now look similar figure 4-5.

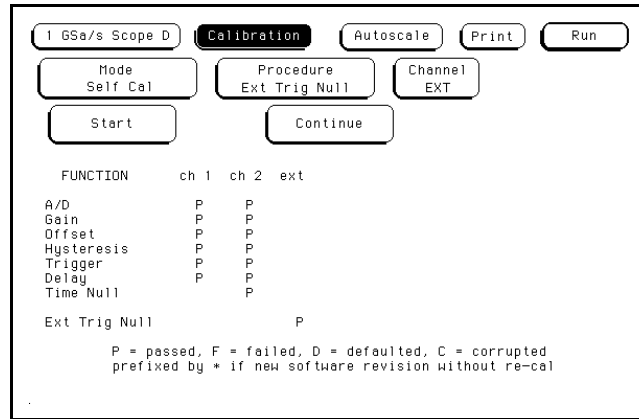

Figure 4-5. End of Calibration Display

### 4-13. Setting the PROTECT/UNPROTECT Switch to PROTECT



*The effects of ELECTROSTATIC DISCHARGE can damage electronic components. Use grounded wrist straps and mats when you are performing any kind of service on this module.*

The PROTECT/UNPROTECT switch must be set to PROTECT after calibration is finished. Set the switch to PROTECT as follows:

1. Remove power from the instrument. Pull the modules located above the oscilloscope halfway out, then remove the filler panels and cards located above the oscilloscope. See figure 4-6 for the removal sequence.

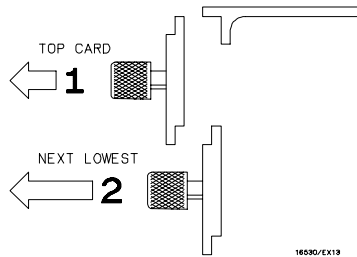

Figure 4-6. Endplate Overlap - Top Sequence

2. Remove the oscilloscope module and set the PROTECT/UNPROTECT switch to the PROTECT position. See Figure 4-2 to locate this switch.
3. Repeat step 2 for each module calibrated.
4. Reinstall the modules and filler panels in reverse order of steps 1 and 2.

### 4-14. Sealing the Mainframe

After calibration has been completed, the mainframe should be sealed to protect the integrity of the system. Place a seal on the equipment such that the seal touches both the top-most module (or filler panel) and the mainframe.

# TABLE OF CONTENTS

## Replaceable Parts

5-1. Introduction .....	5-1
5-2. Abbreviations .....	5-1
5-3. Replaceable Parts List .....	5-1
5-4. Ordering Information .....	5-1
5-5. Exchange Assemblies .....	5-1
5-6. Direct Mail Order System .....	5-2

# SECTION V

## Replaceable Parts

### 5-1. Introduction

The service policy for this instrument is replacement of defective assemblies. This service manual contains information for finding a defective assembly.

This section contains parts and ordering information for the HP 16532A Oscilloscope Module. Table 5-1 lists the reference designator and abbreviations used throughout this manual. Table 5-2 lists all replaceable parts by reference designator.

### 5-2. Abbreviations

Table 5-1 lists abbreviations used throughout the manual. In some cases two forms of the abbreviations are used, one in all capital letters, the other partially or not capitalized. This was done because the abbreviations in the parts list are always all capitals. However, in other parts of the manual other abbreviation forms are used with both lower and uppercase letters.

### 5-3. Replaceable Parts List

Table 5-2 lists replaceable parts and is organized as follows:

- Exchange assemblies in alphanumerical order by reference designation.
- Electrical assemblies in alphanumerical order by reference designation.
- Chassis-mounted parts in alphanumerical order by reference designation.

The information given for each part consists of the following:

- Complete reference designation.
- Hewlett-Packard part number.
- Total quantity.
- Description of part.
- Check digit.

The total quantity for each part is only given once at the first appearance of the part number in the list.

### 5-4. Ordering Information

To order a part listed in the replaceable parts table, quote the Hewlett-Packard part number, check digit, indicate the quantity required, and address the order to the nearest Hewlett-Packard office.

To order a part that is not listed in the replaceable parts table, include the instrument model number, instrument serial number, the description and function of the part, and number of parts required. Address the order to the nearest Hewlett-Packard office.

### 5-5. Exchange Assemblies

Exchange assemblies are available when a repairable assembly is returned to Hewlett-Packard. These assemblies have been set up on the "Exchange Assembly" program. This allows the customer to exchange the faulty assembly with one that has been repaired, calibrated, and performance verified by the factory. The cost is significantly less than that of a new assembly.

Exchange assemblies are listed in a separate section in the replaceable parts table. They have a part number in the form XXXXX-695XX (where the new parts would be XXXXX-665XX). Before ordering an "exchange assembly," check with your local parts or repair organization for procedures.

### **5-6. Direct Mail Order System**

Within the USA, Hewlett-Packard can supply parts through direct mail order. The advantages are as follows:

- Direct ordering and shipment from Hewlett-Packard Parts Center in Mountain View, California.

- No maximum or minimum on any mail order (there is a minimum order for parts ordered through local Hewlett-Packard offices when orders require billing and invoicing).
- Prepaid transportation (there is a small handling charge for each order).
- No invoices - to provide these advantages, check or money order must accompany each order.

Mail order forms and specific ordering information are available through your local Hewlett-Packard offices.

Table 5-1. Reference Designator and Abbreviations

REFERENCE DESIGNATOR							
A	= assembly	F	= fuse	Q	= transistor;SCR; triode thyristor	U	= integrated circuit; microcircuit
B	= fan;motor	FL	= filter	R	= resistor	V	= electron tube; glow lamp
BT	= battery	H	= hardware	RT	= thermistor	VR	= voltage regulator; breakdown diode
C	= capacitor	J	= electrical connector (stationary portion);jack	S	= switch;jumper	W	= cable
CR	= diode;diode thyristor; varactor	L	= coil;inductor	T	= transformer	X	= socket
DL	= delay line	MP	= misc. mechanical part	TB	= terminal board	Y	= crystal unit(piezo-electric or quartz)
DS	= annunciator;lamp;LED	P	= electrical connector (moveable portion);plug	TP	= test point		
E	= misc. electrical part						
ABBREVIATIONS							
A	= amperes	DWL	= dowel	MFR	= manufacturer	RND	= Round
A/D	= analog-to-digital	ECL	= emitter coupled logic	MICPROC	= microprocessor	ROM	= read-only memory
AC	= alternating current	ELAS	= elastomeric	MINTR	= miniature	RPG	= rotary pulse generator
ADJ	= adjust(ment)	EXT	= external	MISC	= miscellaneous	RX	= receiver
AL	= aluminum	F	= farads;metal film (resistor)	MLD	= molded	S	= Schottky-clamped; seconds(time)
AMPL	= amplifier	FC	= carbon film/ composition	MM	= millimeter	SCR	= screw;silicon controlled rectifier
ANLG	= analog	FD	= feed	MO	= metal oxide	SEC	= second(time);second-ary
ANSI	= American National Standards Institute	FEM	= female	MTG	= mounting	SEG	= segment
ASSY	= assembly	FF	= flip-flop	MTLC	= metallic	SEL	= selector
ASTIG	= astigmatism	FL	= flat	MUX	= multiplexer	SGL	= single
ASYNCHRO	= asynchronous	FM	= foam;from	N	= nano(10 <sup>-9</sup> )	SHF	= shift
ATTEN	= attenuator	FR	= front	NC	= no connection	SI	= silicon
AWG	= American wire gauge	FT	= gain bandwidth product	NMOS	= n-channel metal-oxide-semiconductor	SIP	= single in-line package
BAL	= balance	FW	= full wave	NPN	= negative-positive-negative	SKT	= skirt
BCD	= binary-code decimal	FXD	= fixed	NPRN	= neoprene	SL	= slide
BD	= board	GEN	= generator	NRFR	= not recommended for field replacement	SLDR	= solder
BFR	= buffer	GND	= ground(ed)	NSR	= not separately replaceable	SLT	= slot(ted)
BIN	= binary	GP	= general purpose	NUM	= numeric	SOLD	= solenoid
BRDG	= bridge	GRAT	= graticule	OBD	= order by description	SPCL	= special
BSHG	= bushing	GRV	= groove	OCTL	= octal	SQ	= square
BW	= bandwidth	H	= henries;high	OD	= outside diameter	SREG	= shift register
C	= ceramic;cermet (resistor)	HD	= hardware	OP AMP	= operational amplifier	SRQ	= service request
CAL	= calibrate;calibration	HDND	= hardened	OSC	= oscillator	STAT	= static
CC	= carbon composition	HG	= mercury	P	= plastic	STD	= standard
CCW	= counterclockwise	HGT	= height	P/O	= part of	SYNCHRO	= synchronous
CER	= ceramic	HLCL	= helical	PC	= printed circuit	TA	= tantalum
CFM	= cubic feet/minute	HORIZ	= horizontal	PCB	= printed circuit board	TBAX	= tubeaxial
CH	= choke	HP	= Hewlett-Packard	PD	= power dissipation	TC	= temperature coefficient
CHAM	= chamfered	HP-IB	= Hewlett-Packard Interface Bus	PF	= picofarads	TD	= time delay
CHAN	= channel	HR	= hour(s)	PI	= plug in	THD	= thread(ed)
CHAR	= character	HV	= high voltage	PL	= plate(d)	THK	= thick
CM	= centimeter	HZ	= Hertz	PLA	= programmable logic array	THRU	= through
CMOS	= complementary metal-oxide-semiconductor	I/O	= input/output	PLST	= plastic	TP	= test point
CMR	= common mode rejection	IC	= integrated circuit	PNP	= positive-negative-positive	TPG	= tapping
CNDCT	= conductor	ID	= inside diameter	POLYE	= polyester	TPL	= triple
CNTR	= counter	IN	= inch	POS	= positive;position	TRANS	= transformer
CON	= connector	INCL	= include(s)	POT	= potentiometer	TRIG	= trigger(ed)
CONT	= contact	INCAND	= incandescent	POZI	= pozidrive	TRMR	= trimmer
CRT	= cathode-ray tube	INP	= input	PP	= peak-to-peak	TRN	= turn(s)
CW	= clockwise	INTEN	= intensity	PPM	= parts per million	TTL	= transistor-transistor
D	= diameter	INTL	= internal	PRCN	= precision	TX	= transmitter
D/A	= digital-to-analog	INV	= inverter	PREAMP	= preamplifier	U	= micro(10 <sup>-6</sup> )
DAC	= digital-to-analog converter	JFET	= junction field-effect transistor	PRGMBL	= programmable	UL	= Underwriters Laboratory
DARL	= darlington	JKT	= jacket	PRL	= parallel	UNREG	= unregulated
DAT	= data	K	= kilo(10 <sup>3</sup> )	PROG	= programmable	VA	= voltampere
DBL	= double	L	= low	PSTN	= position	VAC	= volt,ac
DBM	= decibel referenced to 1mW	LB	= pound	PT	= point	VAR	= variable
DC	= direct current	LCH	= latch	PW	= potted wirewound	VCO	= voltage-controlled oscillator
DCCR	= decoder	LCL	= local	PWR	= power	VDC	= volt,dc
DEG	= degree	LED	= light-emitting diode	R-S	= reset-set	VERT	= vertical
DEMUX	= demultiplexer	LG	= long	RAM	= random-access memory	VF	= voltage,filtered
DET	= detector	LI	= lithium	RECT	= rectifier	VS	= versus
DIA	= diameter	LK	= lock	RET	= retainer	W	= watts
DIP	= dual in-line package	LKWR	= lockwasher	R-F	= radio frequency	W/O	= without
DIV	= division	LS	= low power Schottky	RGLTR	= regulator	WWW	= wirewound
DMA	= direct memory access	LV	= low voltage	RGTR	= register	XSTR	= transistor
DPDT	= double-pole, double-throw	M	= mega(10 <sup>6</sup> );megohms; meter(distance)	RK	= rack	ZNR	= zener
DRC	= DAC refresh controller	MACH	= machine	RMS	= root-mean-square	oC	= degree Celsius (Centigrade)
DRVR	= driver	MAX	= maximum			oF	= degree Fahrenheit
						oK	= degree Kelvin

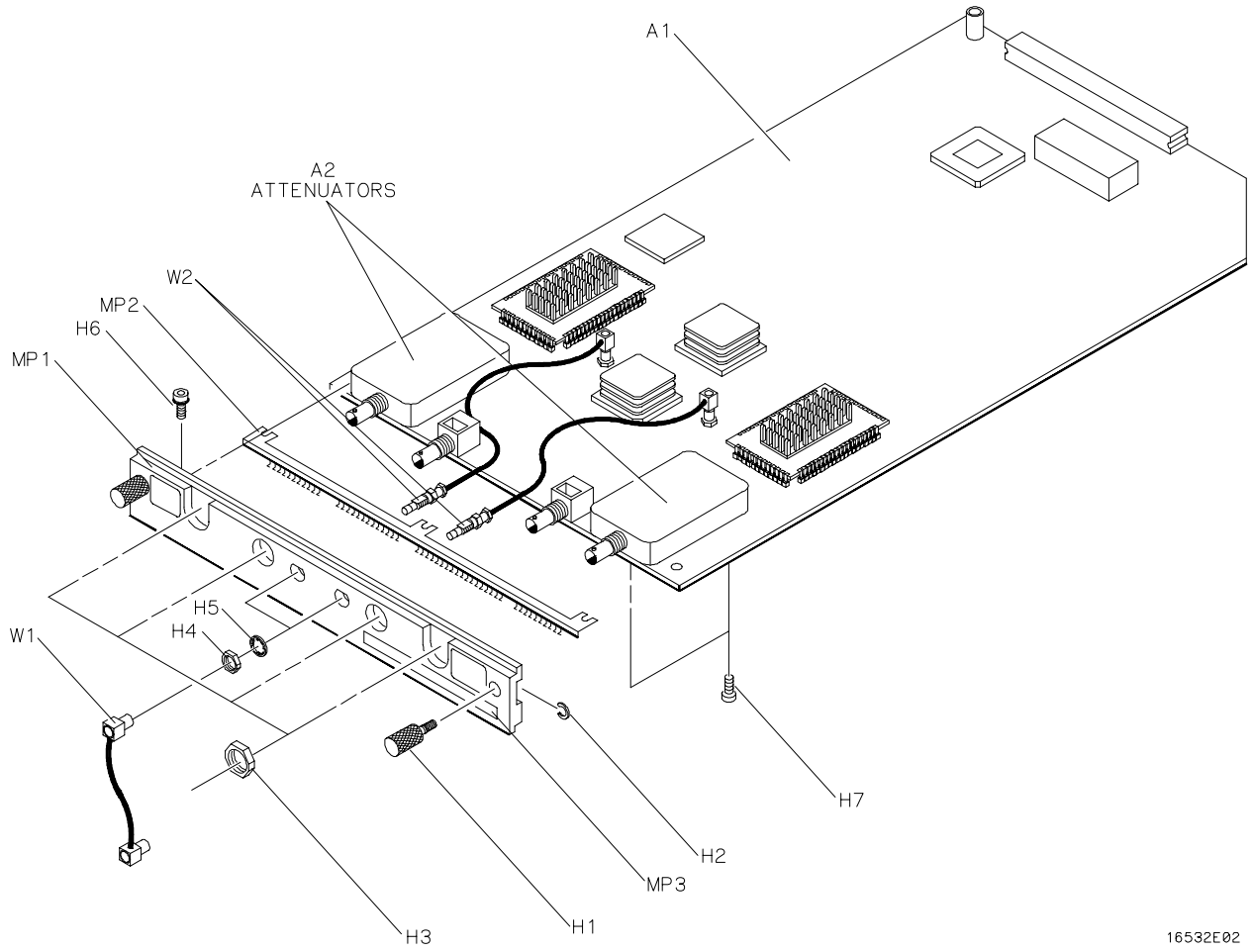

16532E02

Figure 5-1. Parts Identification

Table 5-2. Replaceable Parts List

Reference Designator	HP Part Number	C	Qty	Description	Mfr Code	Mfr Part Number
	16532-69501	2	1	Board Exchange Assembly (does not include attenuator assemblies)		
A1	16532-66501	6	1	Board Assembly (does not include attenuator assemblies)		
A2	16532-63401	9	2	Attenuator Assembly		
H1	16500-22401	5	2	Endplate Thumbscrew		
H2	0510-0684	9	2	Thumbscrew Retaining Ring		
H3	1250-2075	5	4	Nut, Hex, 1/2-inch, RF Connector		
H4			2	Nut, Hex, RF Connector (Included with W2)		
H5			2	Washer, RF Connector (Included with W2)		
H6	0515-0430	3	3	Endplate Screw		
H7	0515-1246	1	4	Attenuator Retainer Screw		
MP1	16532-40501	2	1	Rear Panel		
MP2	16500-29101	6	1	Ground Spring		
MP3	16532-94301	3	1	ID Label		
W1	16532-61601	7	1	Master-Slave Trigger Cable		
W2	16532-61602	8	1	External Trigger Cable		



# TABLE OF CONTENTS

## Service

6-1.	Introduction .....	6-1
6-2.	Safety Requirements .....	6-1
6-3.	Recommended Test Equipment .....	6-1
6-4.	Module Block Diagram and Theory of Operation.....	6-1
6-5.	Attenuator Theory of Operation .....	6-1
6-6.	Main Assembly Theory of Operation .....	6-1
6-7.	Self-Tests .....	6-4
6-8.	Troubleshooting .....	6-10
6-9.	Oscilloscope Module Removal and Replacement .....	6-18
6-10.	Trigger Cable Removal and Replacement .....	6-20
6-11.	Attenuator Removal and Replacement .....	6-21

## SECTION VI Service

### 6-1. Introduction

The service policy for this instrument is replacement of defective assemblies. This service manual contains information for finding a defective assembly. This section contains information for servicing the HP 16532A Oscilloscope Module. Included are a block level theory and procedures for self diagnostics and troubleshooting. If the module or a cable is determined faulty, procedures are provided for module and cable replacement.

### 6-2. Safety Requirements

Specific warnings, cautions, and instructions are placed wherever applicable throughout the manual. These must be observed during all phases of operation, service, and repair of the module. Failure to comply with them violates safety standards of design, manufacture, and intended use of this module. Hewlett-Packard assumes no liability for the failure of the customer to comply with these safety requirements.

### 6-3. Recommended Test Equipment

Table 1-3 lists recommended test equipment. Any equipment that satisfies the critical specification given in the table may be substituted for the recommended models.

### 6-4. Module Block Diagram and Theory of Operation

The following paragraphs contain block level theory of operation. This theory is not intended for component level troubleshooting, rather it is to be used to help isolate a module failure to card level.

The HP 16532A Oscilloscope Module is contained on one board. It runs at a 1 GSa/s digitizing rate, with a 250 MHz single-shot (real-time) bandwidth, 8000 samples per measurement per channel, with 2-channel simultaneous acquisition which is expandable to up to 8 channels. See figure 6-1.

### 6-5. Attenuator Theory of Operation

The channel signals are conditioned by the attenuator/preamps, thick film hybrids containing passive attenuators, impedance converters, and a programmable amplifier. The channel sensitivity defaults to the standard 1-2-4 sequence (other sensitivities can be set also). However, the firmware uses passive attenuation of 1, 5, 25, and 125, with the programmable preamp, to cover the entire sensitivity range.

The input has a selectable 1 M $\Omega$  input impedance with ac or dc coupling or a 50 $\Omega$  input impedance with dc coupling. Compensation for the passive attenuators is laser trimmed and is not adjustable. After the passive attenuators, the signal is split into high-frequency and low-frequency components. Low frequency components are amplified on the main assembly, where they are combined with the offset voltage. The ac coupling is implemented in the low frequency amplifier.

The high- and low-frequency components of the signal are recombined and applied to the input FET of the preamp. The FET provides a high input impedance for the preamp. The programmable preamp adjusts the gain to suit the required sensitivity and provides the output signal to the main assembly. The output signal is then sent to both the trigger circuitry and ADC.

### 6-6. Main Assembly Theory of Operation

#### Acquisition

The acquisition circuitry provides the sampling, digitizing, and storing of the signals from the channel attenuators. The channels are identical. The external trigger (ECL) input cannot be displayed. Trigger signals from each channel and the external triggers synchronize acquisition through the time base circuitry. A 100 MHz oscillator and a time base provide system timing and sample clocking. A voltage-controlled oscillator (VCO), frequency divider, and digital

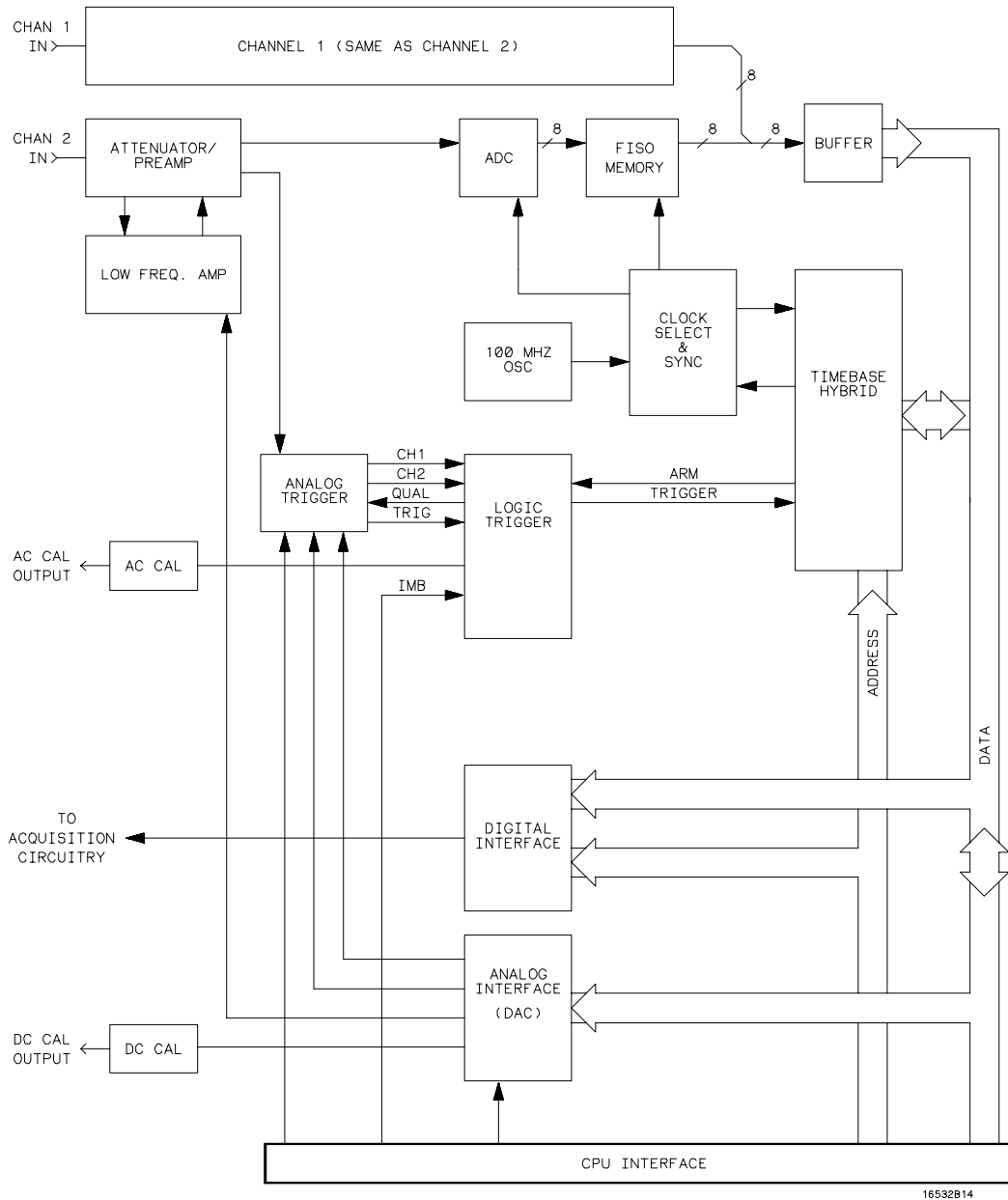

Figure 6-1. HP 16532A Oscilloscope Block Diagram

phase detector provide the sample clock for higher sample rates. After conditioning and sampling, the signals are digitized, then stored in a hybrid IC containing a FISO (fast in, slow out) memory.

**ADC.** The eight-bit ADC digitizes the channel signal. Digitization is done by comparators in a flash converter. The sample clock latches the digitized value of the input to save it so that it can be sent to memory.

**FISO Memory.** 8000 samples of the FISO (fast in, slow out) memory are used per measurement per channel. Memory positions are not addressed directly. The configuration is a ring which loops continuously as it is clocked. Memory position is tracked by counting clocks. The clocking rate is the same as the ADC, however the clock frequency is half that of the ADC since the FISO clocks on both transitions of the clock period. Data is buffered onto the CPU data bus for processing.

**Triggering.** There are two main trigger circuits that trigger four trigger sources. The two trigger circuits are the analog trigger and the logic trigger. The analog trigger IC operates as a multichannel Schmidt trigger/comparator. A trigger signal (a copy of the analog input signal) from each of the inputs is directed to the analog trigger IC inputs. The trigger signal is continuously compared with the trigger reference level selected by the user. Once the trigger condition is met, the trigger TRUE signal is fed to the logic trigger, which begins the acquisition and store functions by way of the time base.

The four trigger sources are Channel 1, Channel 2, Intermodule Bus (IMB), and external BNC. The operation of the input channels was discussed previously. The IMB trigger signal is sent directly to the logic trigger. External triggering is provided by the BNC input of the 16500A Logic Analysis System mainframe.

**Time Base.** The time base provides the sample clocks and timing necessary for data acquisition. It consists of the 100 MHz reference oscillator and time base hybrid.

The 100 MHz reference oscillator provides the base sample frequency.

The time base hybrid has programmable dividers to provide the rest of the sample frequencies appropriate for the time range selected. The time base uses the time-stretched output of the fine interpolator to time-reference the sampling to the trigger point. The time base has counters to control how much data is taken before (pre-trigger data) and after (post-trigger data) the trigger event. After the desired number of pre-trigger samples has occurred, the Time base hybrid sends a signal to the Logic Trigger (trigger arm) indicating it is ready for the trigger event. When the trigger condition is satisfied, the Logic Trigger sends a signal back to the time base hybrid. The time base hybrid then starts the post-trigger delay counter.

When the countdown reaches zero, the sample clocks are stopped and the CPU is signaled that the acquisition is complete. The Fine Interpolator is a dual-slope integrator that acts as a time-interval stretcher. When the logic trigger receives a signal that meets the programmed triggering requirements, it signals the time base. The time base then sends a pulse to the fine interpolator. The pulse is equal in width to the time between the trigger and the next sample clock. The fine interpolator stretches this time by a factor of approximately 500. Meanwhile, the time base hybrid runs a counter with a clock derived from the sample rate oscillator. When the interpolator indicates the stretch is complete, the counter is stopped. The count represents, with much higher accuracy, the time between the trigger and the first sample clock. The count is stored and used to place the recently acquired data in relationship with previous data.

**AC Cal.** The AC Cal is a multiplexer circuit that can provide several signals to the Probe Compensation/AC Calibrator output on the rear panel. The signal provided depends on the mode of the instrument. It can be either a probe compensation signal, a pulse representing the trigger event, signals used for self-calibration, or the 100 MHz reference oscillator when sample period is 1 ns.

**DC Cal.** The DC Cal output, a rear panel signal, is used for self-calibration. It is one output from the 16-channel DAC.

**Digital Interface.** The Digital Interface provides control and interface between the system control and digital functions in the acquisition circuitry.

**Analog Interface.** The Analog Interface provides control of analog functions in the acquisition circuitry. It is primarily a 16-channel DAC with an accurate reference and filters on the outputs. It controls channel offsets and trigger levels, and provides the DC Cal output.

## 6-7. Self-Tests

The self-tests for the HP 16532A oscilloscope module will identify the improper operation of major functional areas in the module. They are not intended for component level diagnostics.

If there are multiple oscilloscope modules, the user must select the specific oscilloscope module to be tested at the main test system menu. Multiple HP 16532A modules that are connected as one unit are recognized as a single unit in the test menu. The external trigger cables connected to the ECL IN and ECL OUT do not need to be removed in order to do the self-test for each board. All other cable connections must be removed.

All self-tests can be run without access to the interior of the instrument. If a self-test fails, refer to section 6-8, "Troubleshooting."

### Self-Test Access Procedure:

1. Disconnect all oscilloscope inputs and turn on the power switch.
2. From the startup screen, shown in figure 6-2, touch the **Configuration** field. Then, touch **Test** in the pop-up menu.

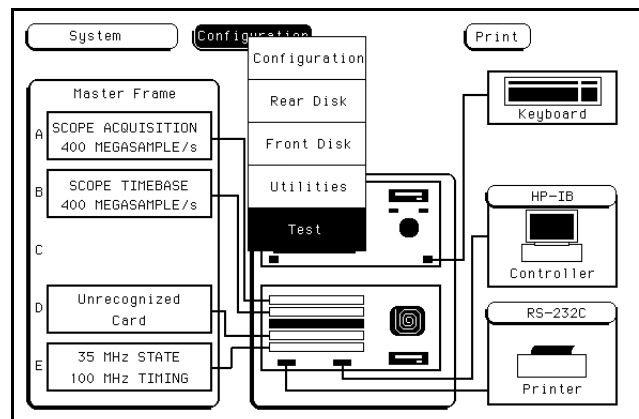

Figure 6-2. Startup Screen

3. Install the Composite PV Test software disk in the inactive disk drive.
4. Touch the box labeled **Touch box to Load Test System**. See figure 6-3.

**Note**

*When the self-test software is loaded, the user operating system is overwritten in the mainframe system RAM.*

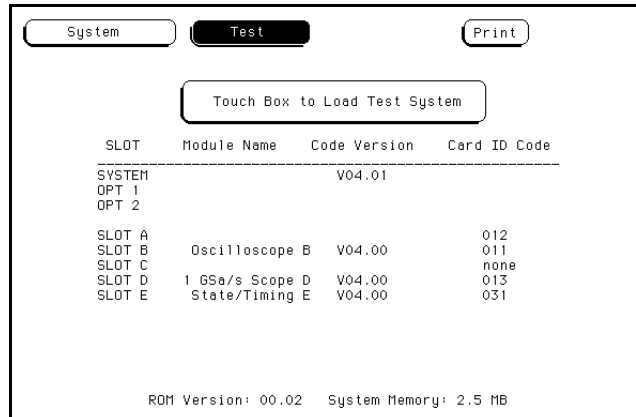

Figure 6-3. Load Test System Screen

5. From the test system screen in figure 6-4, touch **Test System**, then touch **1 GSa/s SCOPE D**. (For the example shown in figure 6-4, the oscilloscope module is in slot D. If multiple oscilloscope modules are present, select the one to be tested.)

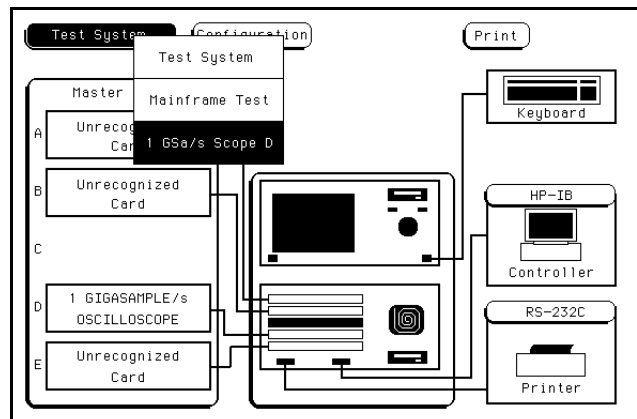

Figure 6-4. Test System Screen

Figure 6-5 shows the selection menu for choosing to perform functional tests. The status of the functional tests is given.

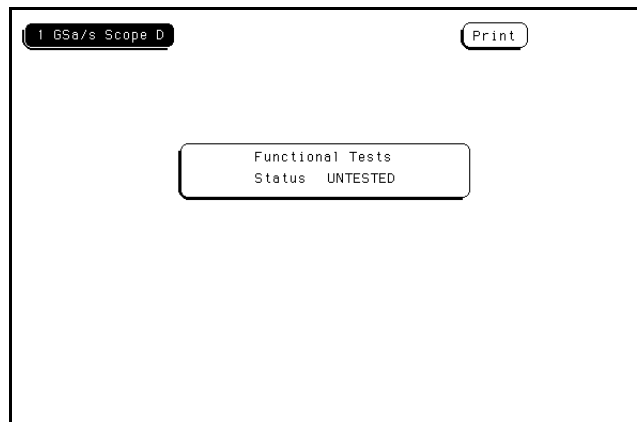

Figure 6-5. Functional Tests Screen

6. Touch the **Functional Tests** field.

Figure 6-6 is the main self-test menu. Self-tests can be either run individually by touching a specific test field, or run automatically through all tests one time by touching the **All Tests** field. When either **All Tests** or individual tests are run, the status will change to either **PASSED** or **FAILED**. If you do all tests by touching the **All Tests** field, skip to step 11. The procedures given in steps 7 through 12 use the A/D Test as an example of how individual tests are done.

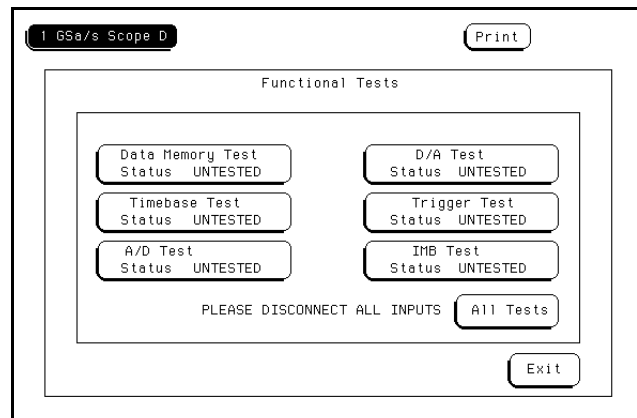

Figure 6-6. Main Test Menu

7. Touch the **A/D Test** field.

The individual test run screens, see figure 6-7, give the test name, a brief description of the test, number of test runs, and the number of test failures.

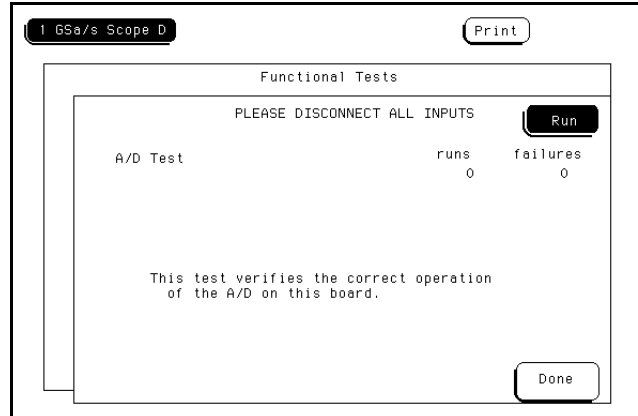

Figure 6-7. A/D Test Run Screen

8. Touch **Run**, then drag your finger to **Single** or **Repetitive**.

During the time a Single run or a Repetitive run is executing, the **Run** field displays **Stop**.

9. To stop a Repetitive run, touch **Stop**. See figure 6-8.

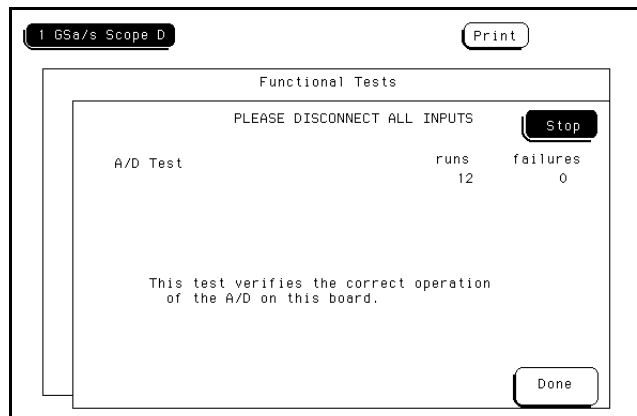

Figure 6-8. Stop Field



10. Touch **Done** to exit the A/D test.
11. To exit the self tests, touch the following fields in the lettered sequence below:
  - a. 1GSa/s Scope
  - b. Test System
  - c. Configuration
  - d. Exit Test
12. Touch the box that reads "Touch box to Exit Test System". See figure 6-9.

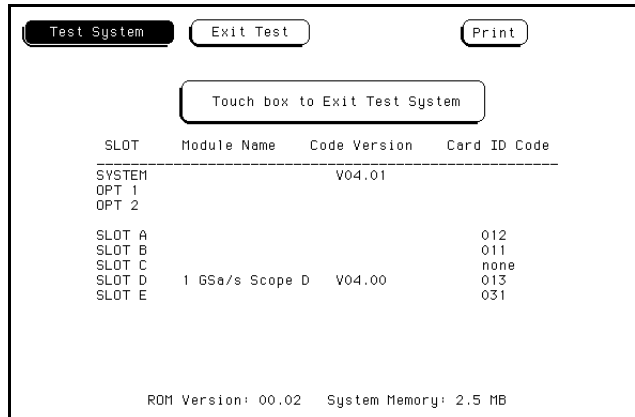

Figure 6-9. Exit Test System Screen

## Self-Test Descriptions

The following self-tests check the major components of the HP 16532A oscilloscope module as well as all associated circuitry. When the self-tests have all been completed with a "PASS" status, the major data and control pipelines in the HP 16532A oscilloscope module are functioning properly.

### Data Memory Test

This test verifies the correct operation of the FISO (fast-in/slow-out) data memory on each board. Test patterns are written into the memory and then read and compared with known values.

### Timebase Test

The pre-trigger and post-trigger delay modes are first tested by programming a predetermined time interval in the trigger counters. At the end of the time intervals, the arm, trigger, and run status bits are read and compared with known values. The coarse and fine interpolators are then checked by reading the values of the interpolator counters after a simulated acquisition. The counter values are then compared with a known value. Finally, the sample clock is checked by programming a sample clock frequency and then reading the status of the clock to detect when one clock period has elapsed. The clock period time interval is then compared with a known value.

### A/D Test

This test verifies the correct operation of the A/D convertor on each board. A check of the trigger in Trigger Immediate mode is first made. The A/D convertors are then exercised by setting the reference voltage and channel offset such that a simulated acquisition obtains data in the extremes and middle of the quantization range of the A/D convertor. After each simulated acquisition, the data is compared with known values.

### D/A Test

This test verifies the correct operation of the D/A convertor on each board. Both the offset and trigger level D/A convertors for each channel are set to a reference level and then changed. The logic trigger IC is programmed to detect the changes. The detection of a correct trigger indicates that the D/A convertor is operating normally.

### Trigger Test

This test verifies the correct operation of the trigger components on each board. First, the logic trigger memory is checked by writing and then reading known patterns. The logic qualifiers, logic trigger output, and trigger holdoff are checked.

### IMB Test

This test verifies the correct operation of the oscilloscope card interface to the intermodule bus.

### All Tests

This will automatically execute each test, one at a time, until all tests are done.

## 6-8. Troubleshooting

The troubleshooting flow chart given in figure 6-10 will isolate module failures to card level only. It is not intended for component level troubleshooting. If self-tests indicate a failure, begin at the **Start** of the troubleshooting flow chart. When a specific test fails, you will be instructed to replace a faulty card or you will be referred to other flow charts for the isolation of the faulty card or cable.

### CAUTION

*The effects of ELECTROSTATIC DISCHARGE can damage electronic components. Grounded wriststraps and mats should be used when you perform any kind of service to this instrument or the cards in it.*

### Troubleshooting Aids

The Calibration menu contains the **Service Cal** mode that can help you troubleshoot the oscilloscope module. When the problem is found and corrected, run all of the calibration procedures given in Section IV, "Calibration."

If you suspect a fault in the system, you can load the system default values to see if the NVRAM parameters have possibly been corrupted. The procedure for loading the default values is given in Section IV under the heading "Loading the Default Calibration Factors."

If loading the default values does not fix the problem, you may want to verify that the system clock is working correctly. The procedure to verify the system clock is given below.

If none of these aids find the problem, go to the troubleshooting flow chart to find the problem. As stated above, when the problem is found and corrected, run all of the calibration procedures given in Section IV "Calibration."

## Verifying the System Clock

This procedure is provided as a troubleshooting aid to verify that the 100 MHz System Clock oscillator is functioning properly. The 100 MHz oscillator is the primary time reference used for all of the acquisition clock periods. The test limits provided are the test limits for the 100 MHz oscillator only. If the readings are outside of the test limits, the oscilloscope module will not operate properly.

Equipment Required	Critical Specification	Recommended Model/Part Number
Frequency Counter	> 100 MHz, 50 $\Omega$	HP 5315A Option 003
Oscilloscope	Bandwidth $\geq$ 100 MHz, Real Time	HP 54502A
Cable	50 $\Omega$ BNC (m to m) 48-inch	HP 10503A

### Procedure:

1. Connect the BNC cable from the AC CAL OUTPUT connector on the rear panel of the HP 16532A oscilloscope module to the input of the frequency counter.
2. On the HP 16532A oscilloscope module, set the following parameters, in the order given.

Menu	Selection	Setting
Channel	s/Div	1 ns
Trigger	Auto-Trig	Off
Calibration	Mode Procedure Signal	Service Cal Osc Out Sample Clk

3. Select RUN-REPETITIVE. Observe the frequency displayed on the frequency counter and verify that it is 100 MHz  $\pm$  0.005%.
4. Disconnect the BNC cable from the frequency counter and connect the cable to the input of the HP 54502A Oscilloscope.

5. On the HP 54502A Oscilloscope, set the following parameters, in the order given.

Menu	Selection	Setting
Channel	Probe	1.000:1
	V/Div	200 mV
	Offset	0.0 V
	Coupling	DC
Timebase	s/Div	10 ns
	Acquisition	Realtime
Trigger	Mode	Edge
	Level	- 200 mV
	Slope	Falling

6. In the HP 16532A Oscilloscope trigger menu, select **Auto-Trig On**. Verify that the 100 MHz System Clock is gated.
7. Select STOP on both the HP 54502A and HP 16532A oscilloscopes.
8. Disconnect the cable from both oscilloscopes.

**Troubleshooting Sheet 1**

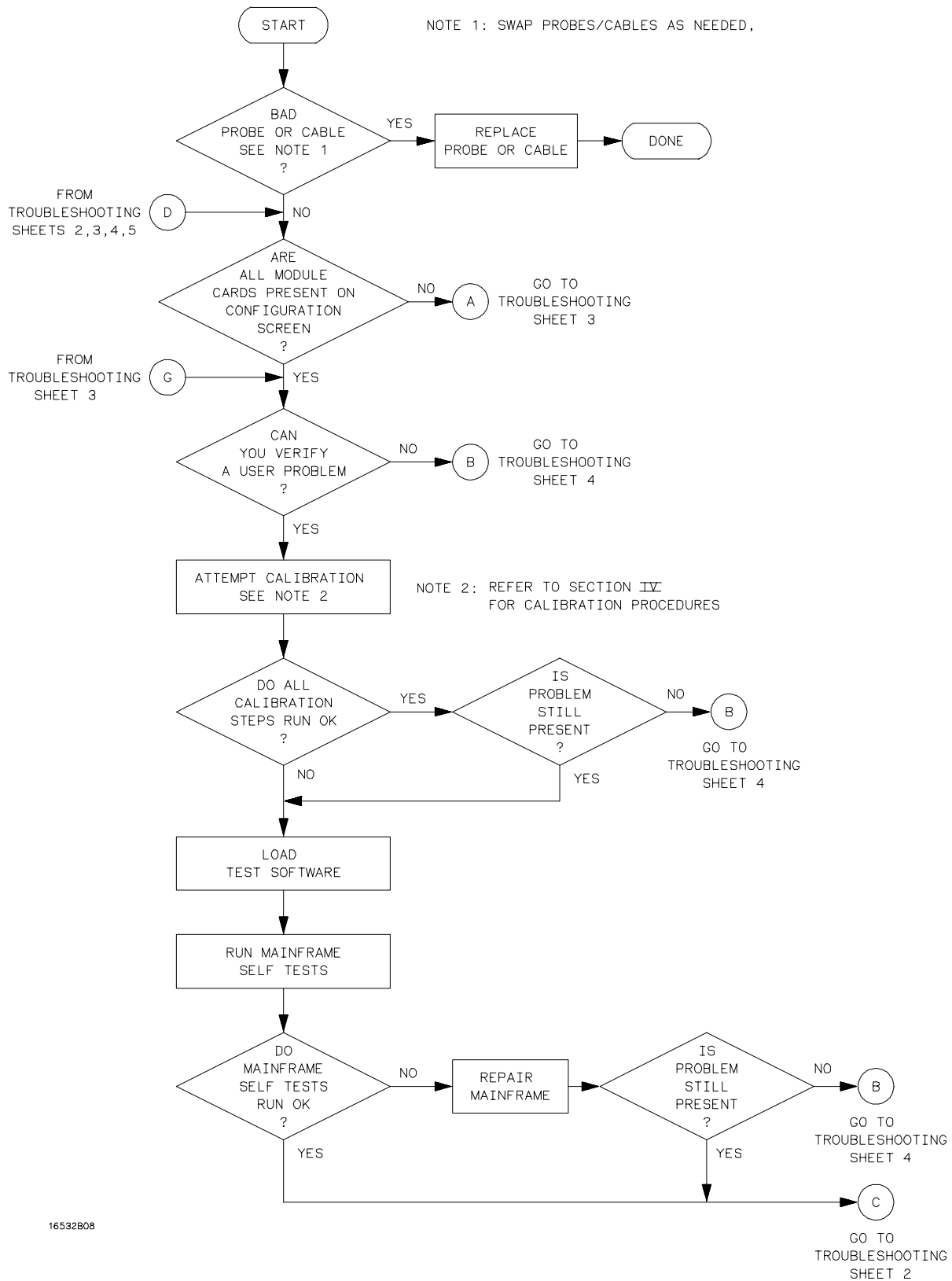

Figure 6-10. Troubleshooting Flowchart

**Troubleshooting Sheet 2**

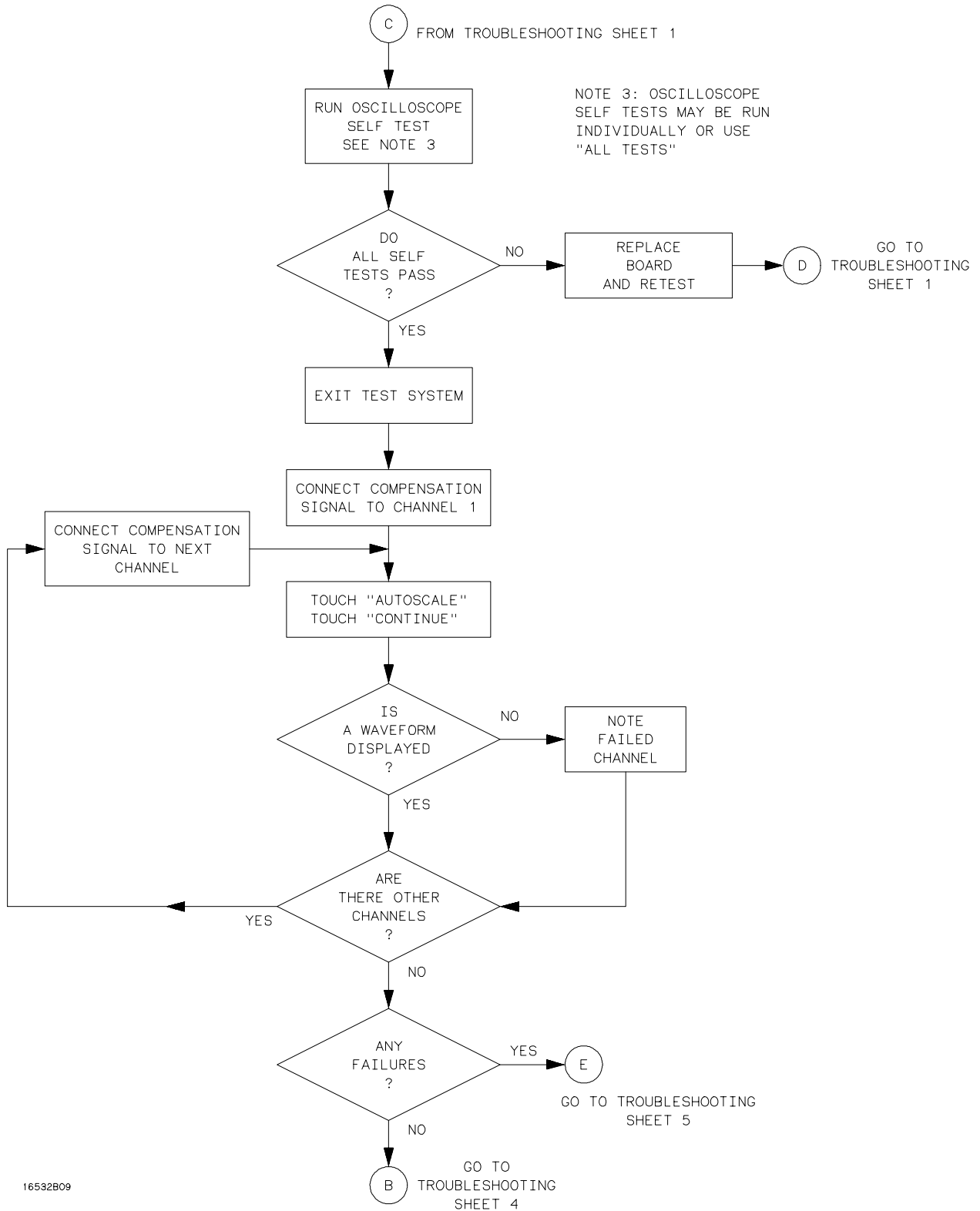
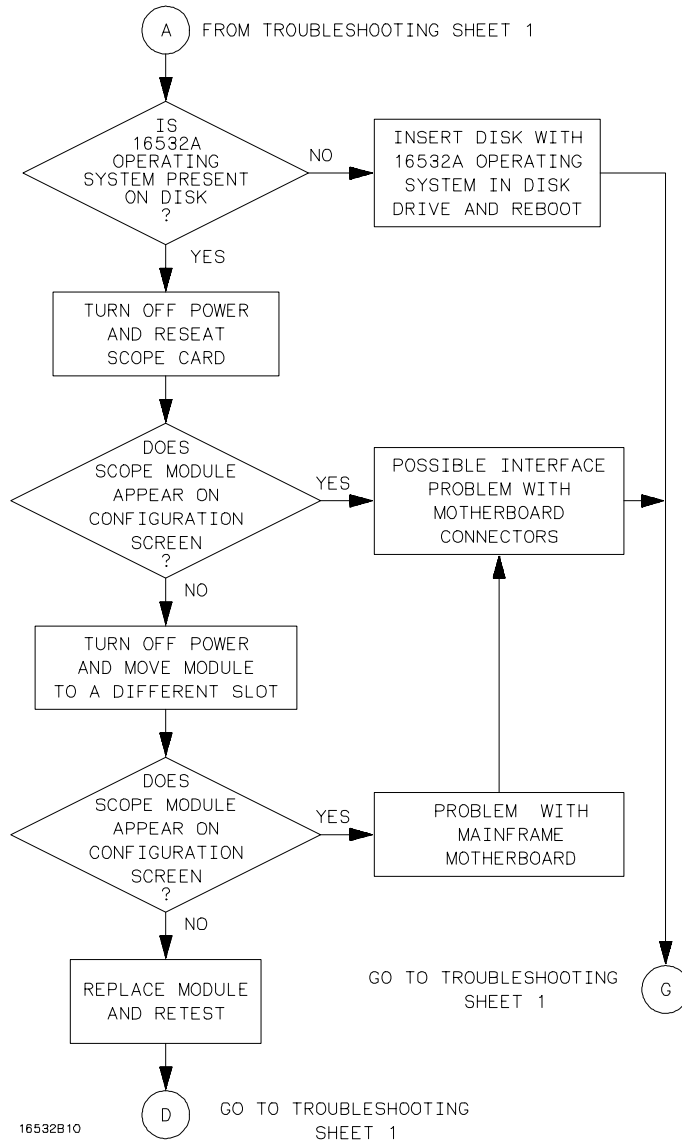

Figure 6-10. Troubleshooting Flowchart

**Troubleshooting Sheet 3**



16532B10

*Figure 6-10. Troubleshooting Flowchart*



### Troubleshooting Sheet 4

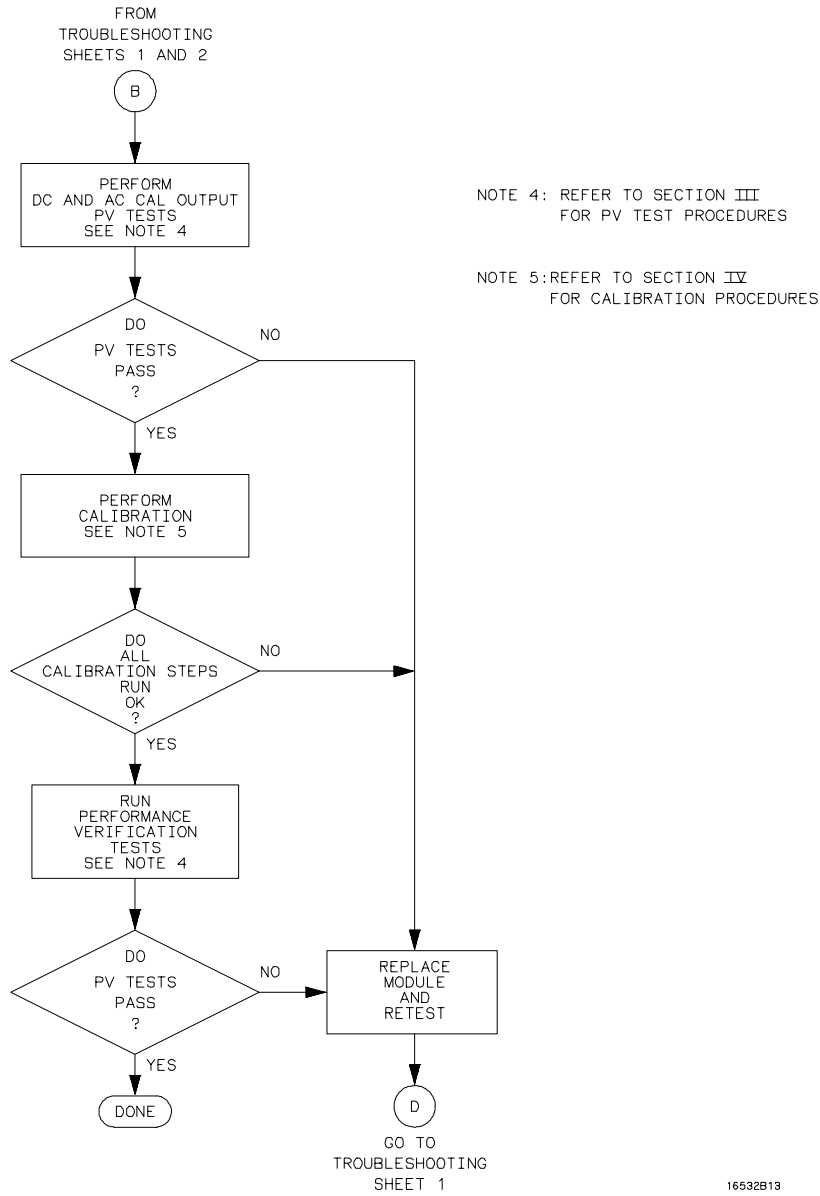
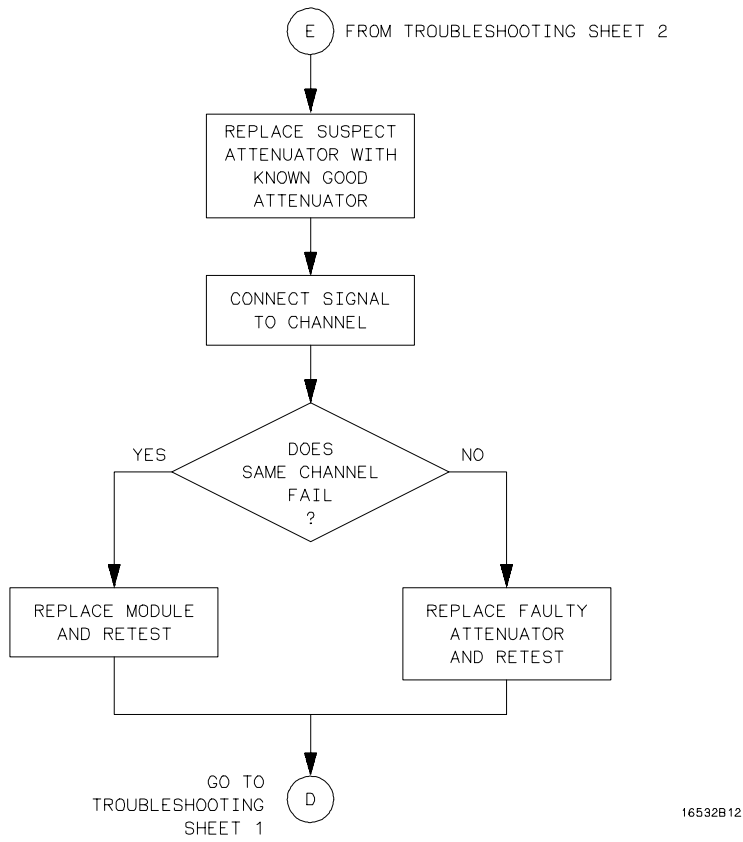

Figure 6-10. Troubleshooting Flowchart

**Troubleshooting Sheet 5**



*Figure 6-10. Troubleshooting Flowchart*

## 6-9. Oscilloscope Module Removal and Replacement

### CAUTION

*The effects of ELECTROSTATIC DISCHARGE can damage electronic components. Use grounded wrist straps and mats when you are performing any kind of service on this module.*

When you need to remove and replace a module, test the module first to determine the faulty part. If either of the trigger cables are faulty, remove the faulty cable and replace it with a new one. Refer to paragraph 6-10 for procedures to remove and replace a faulty cable. If either of the attenuators are faulty, remove the faulty attenuator and replace it with a new one. Refer to paragraph 6-11 for procedures to remove and replace a faulty attenuator.

### Oscilloscope Module Removal Procedure:

### CAUTION

*Do not install, remove or replace the module in the instrument unless the instrument power is turned off.*

1. Turn off the instrument power switch, unplug the power cord, and disconnect any input or output connections.
2. Starting **from the top**, loosen the thumb screws on the filler panels and the cards. See figure 6-11.

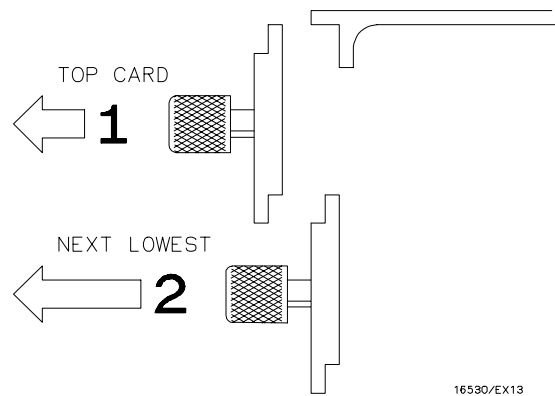

Figure 6-11. Endplate Overlap - Top Sequence

3. Starting **from the top**, pull out the cards and the filler panels **halfway**.
4. Pull out the oscilloscope module completely.

5. If a trigger cable was determined to be faulty, replace the faulty trigger cable on the oscilloscope module (refer to paragraph 6-10). Otherwise, skip to step 6.
6. If an attenuator was determined to be faulty, replace the faulty attenuator on the oscilloscope module (refer to paragraph 6-11). Otherwise, skip to step 7.
7. If the oscilloscope module was determined to be faulty, remove the attenuators from the oscilloscope module (refer to paragraph 6-11).
8. Acquire a replacement oscilloscope module and install the attenuators on the replacement oscilloscope module (refer to paragraph 6-11).
9. Reinstall the repaired (or replacement) oscilloscope module in the mainframe (refer to the next procedure "Oscilloscope Module Replacement Procedure").

### Oscilloscope Module Replacement Procedure

1. If you have not already done so, pull the installed boards half way out of the card slots (refer to steps 1 through 3 of the preceding procedure "Oscilloscope Module Removal").
2. Determine which modules you want to install in the mainframe, and the slots where you want them installed.
3. Starting with the bottom slot, slide each module to be installed approximately halfway into the mainframe card slot.
4. Firmly seat the bottom card into the backplane connector. **Keep applying pressure to the center of the card endplate while tightening the thumb screws finger tight.**
5. Repeat step 4 for all cards and filler panels in a bottom-to-top order. See figure 6-12.

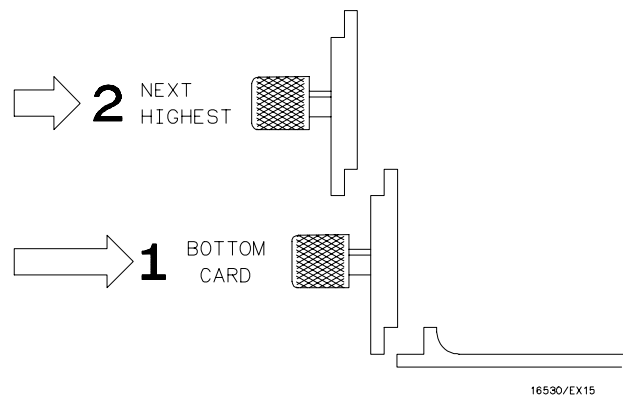

Figure 6-12. Endplate Overlap - Bottom Sequence

6. Any filler panels that are not used should be kept for future use. Filler panels **must** be installed in all unused card slots for correct air circulation.

## 6-10. Trigger Cable Removal and Replacement

### CAUTION

*The effects of ELECTROSTATIC DISCHARGE can damage electronic components. Use grounded wriststraps and mats when performing any kind of service to this instrument or the cards in it.*

#### Trigger Cable Removal Procedure:

1. Follow the procedures given in paragraph 6-9 "Oscilloscope Module Removal and Replacement" to remove the HP 16532A Oscilloscope Module to be serviced.
2. Remove the hex nut (H4) and the washer (H5) from the SMB connector on the cable to be removed. See figure 6-13.

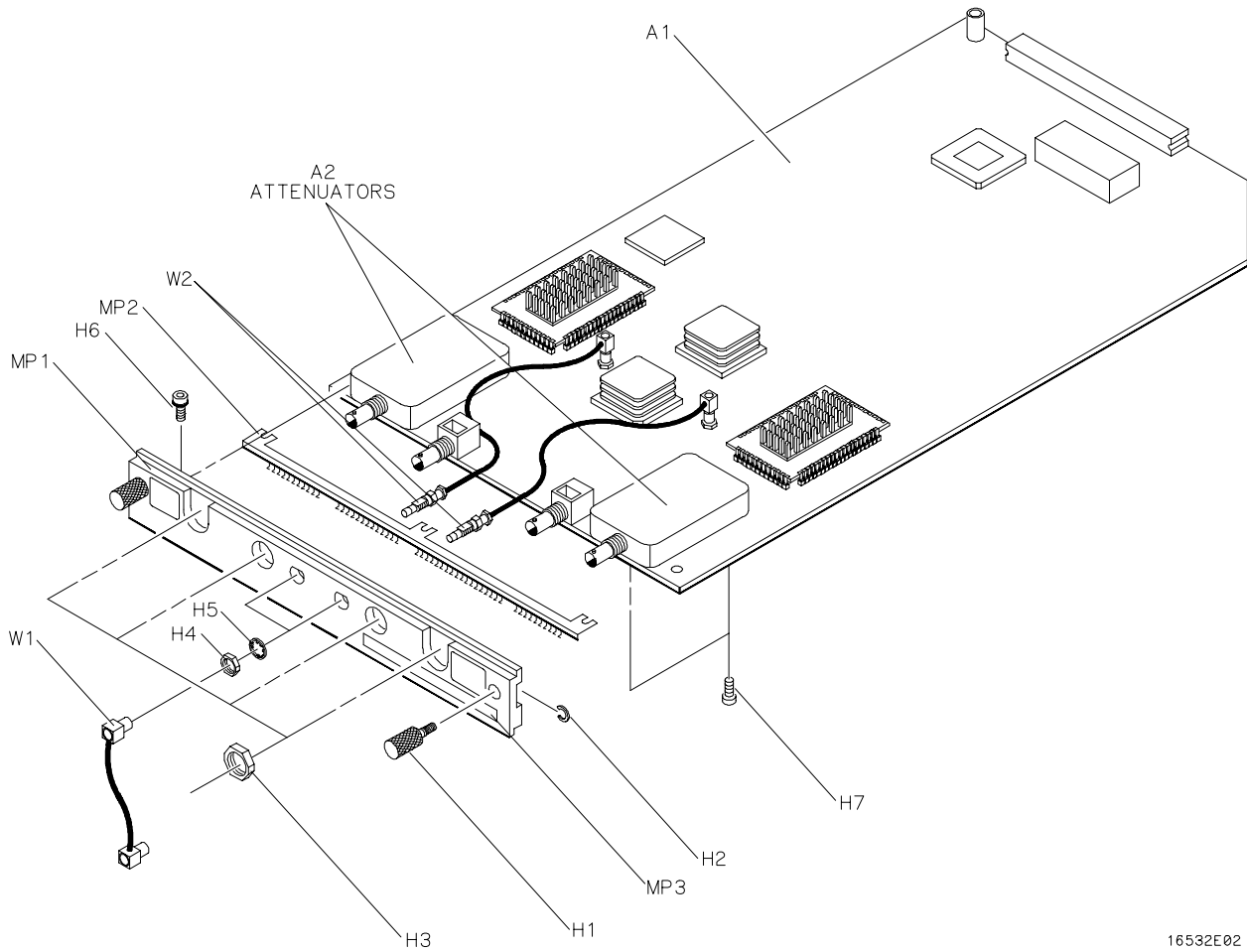

16532E02

Figure 6-13. Oscilloscope Module Exploded View

3. Pull the straight SMB connector on the cable through the hole in the rear panel.
4. Pull the right-angle SMB connector on the cable away from its mating connector on the board.
5. Install a new cable (refer to the next paragraph).

**Trigger Cable Replacement Procedure:**

1. Install the straight SMB connector on the cable through the hole in the rear panel. See figure 6-13.
2. Attach the washer (H5) and the hex nut (H4) to the straight SMB connector on the cable. Tighten the hex nut.
3. Connect the right-angle SMB connector on the cable to its mating connector on the board.

## 6-11. Attenuator Removal and Replacement

**CAUTION**

*The effects of ELECTROSTATIC DISCHARGE can damage electronic components. Use grounded wriststraps and mats when performing any kind of service to this instrument or the cards in it.*

**Attenuator Removal Procedure:**

1. Follow the procedures given in paragraph 6-9 "Oscilloscope Module Removal and Replacement" to remove the HP 16532A Oscilloscope Module to be serviced.
2. Remove the four hex nuts (H3) from the BNC connectors on the rear panel (MP1). See figure 6-13.
3. Remove the two hex nuts (H4) and the two washers (H5) from the SMB connectors on the rear panel.
4. Remove the three end plate screws (H6) holding the rear panel (MP1) and the ground spring (MP2) to the board assembly (A1).
5. Pull the rear panel (MP1) and the ground spring (MP2) from the board assembly (A1). You may need to loosen the attenuator retainer screws (H7) before removing the ground spring.
6. Remove the two attenuator retainer screws (H7) holding the attenuator assembly (A2) to the board assembly (A1).
7. Gently pull the attenuator assembly (A2) straight up from the board assembly (A1) being careful not to damage the connector and the components beneath the attenuator assembly.
8. Install a new attenuator assembly (refer to the next paragraph "Attenuator Replacement Procedure").

**Attenuator Replacement Procedure:**

- a. Gently push the attenuator assembly (A2) straight down on the board assembly (A1) being careful not to damage the connector and the components beneath the attenuator assembly. See figure 6-13.
- b. Attach the attenuator assembly (A2) to the board assembly (A1) with the two attenuator retainer screws (H7).
- c. Assemble the rear panel (MP1) and the ground spring (MP2) to the board assembly (A1) and attach them with the three end plate screws (H6). You may need to loosen the attenuator retainer screws (H7) before assembling the ground spring to the board assembly, then tighten the attenuator screws (H7) when the assembly is finished.
- d. Attach the SMB connectors to the rear panel (MP1) with two hex nuts (H4) and two washers (H5).
- e. Attach the BNC connectors to the rear panel (MP1) with four hex nuts (H3).

**Note**

*Tighten the hex nuts down so that they will not interfere with the installation of the board above the oscilloscope module. One of the flat surfaces on the outside edge of the nut should be parallel with the top edge of the rear panel.*